

ECP200 EXPERT PULSE

for EEV PULSE 230V

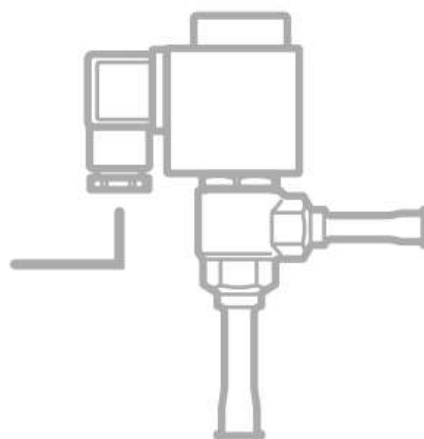

Use and maintenance manual

ENGLISH

READ AND KEEP

Rel. Software: 5

REV. 01-21
ENG

ELECTRICAL BOARDS FOR REFRIGERATING INSTALLATIONS



CONTENTS

INTRODUCTION

CHAP. 1

Page 3	1.1	General information
Page 4	1.2	Product ID codes
Page 4	1.3	Overall dimensions
Page 4	1.4	Identification data

INSTALLATION

CHAP. 2

Page 5	2.1	Important information for the installer
Page 5	2.2	Standard assembly kit
Page 6	2.3	Installing the unit

TECHNICAL CHARACTERISTICS

CHAP. 3

Page 8	3.1	Technical characteristics
--------	-----	---------------------------

WARRANTY

CHAP. 4

Page 9	4.1	Warranty
--------	-----	----------

PARAMETER PROGRAMMING

CHAP. 5

Page 10	5.1	Control panel
Page 10	5.2	Frontal keypad
Page 11	5.3	LED display
Page 12	5.4	Key shortcut
Page 12	5.5	Setting and display of the set point
Page 13	5.6	Level 1 programming
Page 13	5.7	List of Level 1 variables
Page 14	5.8	Level 2 programming
Page 14	5.9	List of Level 2 variables
Page 18	5.10	Level 3 programming
Page 18	5.11	List of Level 3 variables
Page 21	5.12	Loading defaults under variable EEV
Page 21	5.13	Temperature table for refrigerant fluids
Page 22	5.14	Quick menu displaying variables
Page 22	5.15	List of quick menu displaying variables
Page 23	5.16	Mode of operation thermostat
Page 23	5.17	Password protection
Page 23	5.18	Emergency operation in the event of an E0 error
Page 23	5.19	Manual activation of defrost
Page 24	5.20	Force manual defrost end
Page 24	5.21	Defrost with heater and temperature control
Page 24	5.22	Hot gas defrosting
Page 24	5.23	Displaying temperature after defrost
Page 24	5.24	Pump down function

OPTIONS

CHAP. 6

Page 25	6.1	TeleNET monitoring / supervision system
Page 25	6.2	Net configuration with Modbus-RTU protocol

TROUBLESHOOTING

CHAP. 7

Page 26	7.1	Troubleshooting
---------	-----	-----------------

APPENDICES

Page 28	A.1	EU Declaration of Conformity
Page 29	A.2	Connection Diagram
Page 30	A.3	Part list

CHAPTER 1: INTRODUCTION

GENERAL INFORMATIONS

1.1

DESCRIPTION:

The **ECP200 EXPERT PULSE** is a control panel for cold rooms with magneto-thermal cut-out switch for the management of a refrigeration system, with integrated control for electronic expansion valve ON / OFF with coil to 230VAC and single-phase compressor up to 2 HP.

It allows the user to control all the components on a refrigerating system: compressor, EEV pulse, evaporator fans, defrosting elements room light and thermostat-holder demisting element.

APPLICATIONS:

- Complete management of single-phase static or ventilated refrigeration systems up to 2 HP, with off-cycle or electrical defrosting and with direct or pump-down compressor stop.
- For plants with evaporator managed by the electronic expansion valve ON/OFF at 230Vac.
- Real time clock defrosting.
- Control of single-phase evaporator unit only with electronic expansion valve ON/OFF 230Vac or remote condensing unit enable signal.

MAIN CHARACTERISTICS:

- Compatible with 23 gases:
R404, R134, R22, R407A, R407F, R407H, R410A, R450A, R507, R513A, R744(CO₂), R449A, R290, R32, R448A, R452A, R600, R600A, R1270, R1234ze, R23, R717(NH₃), R454C.
- Cold room temperature displaying and regulation with decimal point.
- Evaporator temperature displaying from parameter.
- Plant control activation/deactivation.
- Plant alarms signalling (probe error, minimum and maximum temperature alarm, compressor protection).
- LED indicators and large display illustrate system status.
- User-friendly keypad.
- Evaporator fans management.
- Manual and automatic defrost (static, through heaters, through cycle reversal).
- Direct or pump-down management and control of condensing unit up to 2HP.
- Cold room light activation through key on the panel or through door-switch.
- Direct control of compressor, defrosting elements, evaporator fans, room light with outputs directly connectable to the various units.
- Magneto-thermal cut-out switch for isolation and protection of the refrigeration unit.
- Innovative, smartly designed ABS cover with transparent cover for access to the magneto-thermal cut-out switch, all with an IP65 protection rating so that panel can be used outside the room.
- Auxiliary relay with parameter-configured.
- Possibility, as an alternative to an auxiliary relay, of a RS485 port for connection to the TeleNET supervision net or to a net with MODBUS-RTU protocol.

1.2

PRODUCT ID CODES

200200EXPEEV

Controls and manages compressor, defrosting elements, evaporator fans and room light.

Aux/Alarms relay.

It is compatible with the most common 230VAC ON/OFF electronic expansion valves.

Evaporator superheat control.

Differential magneto thermic circuit breaker 16A

Id=300 mA (Id=30 mA on request)

1.3

OVERALL DIMENSIONS

Dimensions (mm)



1.4

IDENTIFICATION DATA

The unit described in this manual has an ID plate on the side showing all the relevant identification data:

- Name of Manufacturer
- Code of electrical board
- Serial number
- Power supply
- Rated current
- IP protection rating

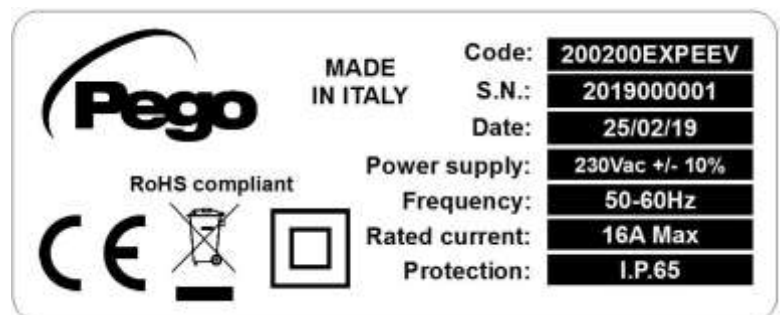

CHAPTER 2: INSTALLATION

GENERAL WARNINGS FOR THE INSTALLER

2.1

1. Install the device in places where the protection rating is observed and try not to damage the box when drilling holes for wire/pipe seats.
2. Do not use multi-polar cables in which there are wires connected to inductive/power loads or signalling wires (e.g. probes/sensors and digital inputs).
3. Do not fit power supply wiring and signal wiring (probes/sensors and digital inputs) in the same raceways or ducts.
4. Minimise the length of connector wires so that wiring does not twist into a spiral shape as this could have negative effects on the electronics.
5. Install a general protection fuse upstream of the electronic control.
6. All wiring must be of a cross-section suitable for relevant power levels.
7. When it is necessary to make a probe/sensor extension, the wires must have a cross-section of at least 1mm². Probes extension or shortening could alter their factory calibration; therefore, to check and calibrate the probes through an external thermometer.
8. Tighten the 4 closing screws of the electrical panel with a torque not exceeding 1 newton meter

STANDARD EQUIPMENT INCLUDED FOR INSTALLATION AND OPERATION

2.2

The electronic controller **ECP200 EXPERT PULSE**, is equipped with the following for installation and operation:

- 3 sealing gaskets, to place between the fastening screws and the base of the box;
- 2 NTC temperature probes (one is 1.5m and one is 3m);
- 1 user manual.

2.3

INSTALLING THE ELECTRICAL PANEL

Fig.1: Lift the transparent door that protects the differential magneto thermal circuit breaker and remove the cover for the screws on the right side.



Fig. 2: Remove the 4 fastening screws from the front panel of the box.



Fig. 3: Close the transparent door that protects the differential magneto thermal circuit breaker.



Fig. 4: Open the front panel of the box by lifting it and sliding the two hinges until they reach the end stop.



Fig. 5: Press on the sides of each hinge to unlodge it and completely remove the front panel.



Fig. 6: Use the three pre-existing holes to fasten the base of the box with three adequately long screws based on the thickness of the wall that the panel will be installed on. Place a rubber washer (included) between each fastening screw and the base of the box.

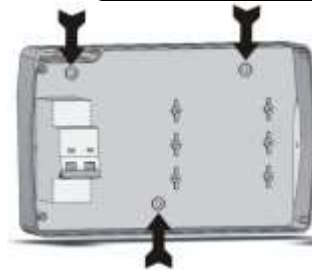
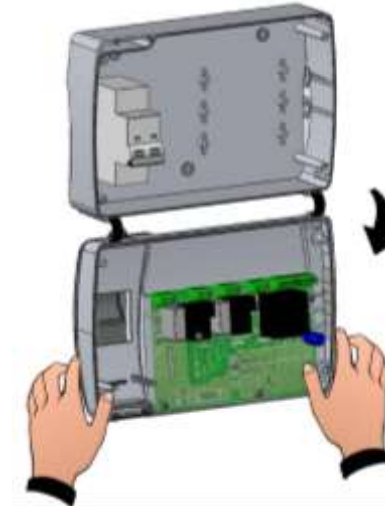

Fig. 7: Hook the front panel back on to the base of the box by re-inserting the hinges into their slots and making them bend. Rotate the panel downwards by 180° to access the PCB.



Make all of the electrical connections according to the attached diagrams for the corresponding model (see the relative tables in ANNEXES). To make the electrical connections in a secure manner and maintain the degree of IP protection of the box it is advisable to use suitable cable and/or conduit glands to seal all of the cables. It is advisable to distribute the arrangement of the conductors inside the panel in the most orderly manner possible, and especially keep the power conductors away from the signal ones. Use sealing straps if necessary.



Fig. 8: Close the front panel again, paying attention that the cables are inside the box and that the gasket for the box is correctly lodged into place. Fasten the front panel with the 4 screws with a torque not exceeding 1 newton meter. Power the panel and perform a thorough reading/programming of all of the set parameters.



Be sure not to tighten the closing screws excessively as this could cause the box to become deformed and jeopardise its correct functioning and tactile effect of the keyboard on the panel; do not exceed 1 newton meter of torque. Install protection devices against power surges for short-circuits, in order to avoid damage to the device on all of the loads connected to the electronic controller ECP200 EXPERT PULSE. Every time repair and/or maintenance is performed the panel must be disconnected from the power supply and from all possible inductive and power loads that it may be connected to; this is to guarantee the maximum safety conditions for the operator.



CHAPTER 3: TECHNICAL FEATURES

3.1

TECHNICAL FEATURES

Power supply			
Voltage	230V~ ± 10% 50-60Hz		
Max. absorbed power (only electronic control)	~ 7 VA		
Maximum absorption allowed (With all loads connected)	16A		
Climatic Conditions			
Working temperature	-5 ÷ +50 °C		
Storage temperature	-10 ÷ +70 °C		
Ambient relative humidity	Below 90% Hr		
General Features			
Type of temperature probes that can be connected	Temperature probes: NTC 10K 1%		
Resolution	0.1 °C		
Precision of the probe readings	± 0,5 °C		
Range of reading	-45 ÷ +45 °C		
Type of pressure probe that can be connected:	Pressure probe: 4/20mA / ratiometric 0-5V		
Output features			
Description	Relay installed	Features outputs board	Notes
Compressor	(Relay 30A AC1)	10A 250V~ (AC3) (2HP) (100000 cycles)	The sum of contemporary absorptions of the following loads must not exceed 16A
Resistances	(Relay 30A AC1)	16A 250V~ (AC1)	
Fans	(Relay 16A AC1)	2,7A 250V~ (AC3)	
Cold room light	(Relay 16A AC1)	16A 250V~ (AC1)	
Alarm/Aux (voltage-free contact)	(Relay 8A AC1)	8(3)A 250V~	
Pulse valve	triac	50VA Pulse valve	
General electric protection		Bipolar magneto thermal differential circuit breaker 16A Id=300mA (Id=30mA upon request) Power of interruption 4.5 kA	
Features of the measurements			
Measurements	18cm x 9.6cm x 26.3cm (HxPxL)		
Insulation and mechanical features			
Degree of IP protection for the box	IP65		
Box material	ABS self-extinguishing		
Type of insulation	Class II		

ECP200 EXPERT PULSE series products are covered by a 24-months warranty against all manufacturing defects as from the date indicated on the product ID code.

In case of defect the product must be appropriately packaged and sent to our production plant or to any authorized Service Center with the prior request of the Return Authorization Number.

Customers are entitled to have defective products repaired, spare parts and labour included. The costs and the risks of transport are at the total charge of the Customer. Any warranty action does not extend or renew its expiration.

The Warranty does not cover:

- Damages resulting from tampering, impact or improper installation of the product and its accessories.
- Installation, use or maintenance that does not comply with the instructions provided with the product.
- Repair work carried out by unauthorized personnel.
- Damage due to natural phenomena such as lightning, natural disasters, etc...

In all these cases the costs for repair will be charged to the customer.

The intervention service in warranty can be refused when the equipment is modified or transformed.

Under no circumstances **Pego S.r.l.** will be liable for any loss of data and information, costs of goods or substitute services, damage to property, people or animals, loss of sales or earnings, business interruption, any direct, indirect, incidental, consequential, damaging, punitive, special or consequential damages, in any way whatsoever caused, whether they are contractual, extra contractual or due to negligence or other liability arising from the use of the product or its installation.

Malfunction caused by tampering, bumps, inadequate installation automatically declines the warranty. It is compulsory to observe all the instructions in this manual and the operating conditions of the product.

Pego S.r.l. disclaims any liability for possible inaccuracies contained in this manual if due to errors in printing or transcription.

Pego S.r.l. reserves the right to make changes to its products which it deems necessary or useful without affecting its essential characteristics.

Each new release of the Pego product user manual replaces all the previous ones.

As far as not expressly indicated, is applicable the Law and in particular the art. 1512 C.C. (Italian Civil Code).

For any controversy is elected and recognized by the parties the jurisdiction of the Court of Rovigo.

CHAPTER 5: PARAMETER PROGRAMMING



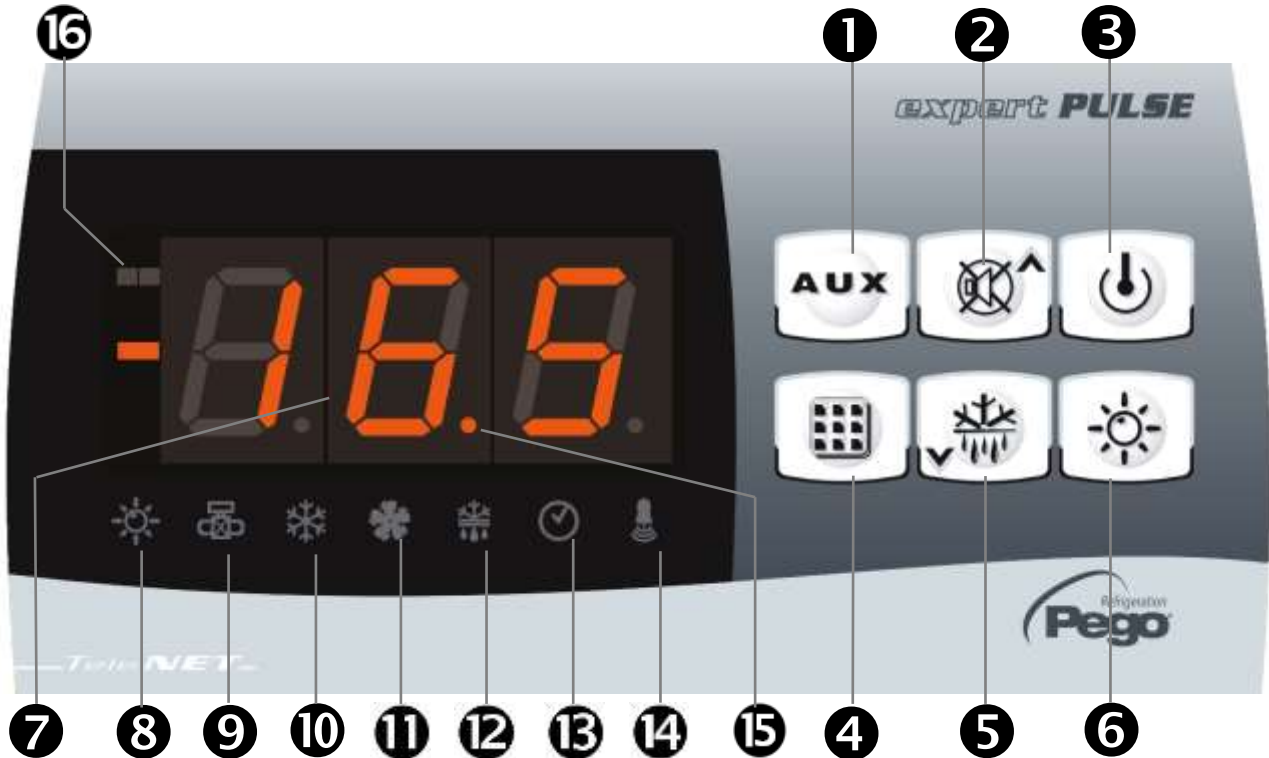

5.1

FRONT KEYBOARD



5.2

KEYBOARD

- 1**  **AUXILIARY RELAY COMMAND/VIEWING CURRENT DATE AND TIME**
Command the relay manually if parameter AU1=2
If pressed for 3 seconds it displays the current date/time (**when AU1≠2**).
- 2**  **UP / MUTE KEY BUZZER ALARM**
Increments the values / Scrolls the parameters upwards
Mutes the acoustic alarm if included / Acquires an alarm (if the alarm has been resolved and the bell is still on, it can be turned off by pressing this key which acquires the alarm).
If pressed for 3 seconds at the same time as the stand-by key you can access menu level 3 (EEV parameters).
- 3**  **STAND BY**
Pressed for more than 1 second alternates the Stand-by status to normal functioning status, and vice-versa. A confirmation beep is emitted upon occurred change-over.
In stand-by status, the system stops and the screen displays the word OFF and the temperature alternately (if included in programming the word OFF will not be displayed alternately).
- 4**  **AMBIENT TEMPERATURE SET**
View the set point
Enables setting the set point if pressed at the same time as the Down or UP key.
Restores audio alarm, if included.

- 5**  **DOWN / DEFROST**
 When pressed for more than 3 seconds manual defrost is turned on (if the conditions to turn it on subsist).
 When pressed for more than 3 seconds during a defrost function, this operation will be terminated.

- 6**  **COLD ROOM LIGHT**

DISPLAY LED

5.3

- 7** **VALUE OF THE AMBIENT TEMPERATURE / PARAMETERS**

- 8**  **MICRO DOOR / COLD ROOM LIGHT ICON**
 Led OFF = Micro door not Active or not used and cold room light off
 Led ON = Cold room light ON
 Flashing Led = Micro door Active and cold room light ON

- 9**  **OUTPUT STATUS ICON** EEV Output status for the electronic valve EEV (if enabled)
 Led OFF = EEV output OFF
 Led ON = EEV output ON

- 10**  **COLD CALL / COMPRESSOR DRIVE ICON**
 Led OFF = Cold call OFF
 Led ON = Cold call ON
 Flashing Led = Cold call ON but awaiting waiting time C1

- 11**  **FANS CALL ICON**
 Led OFF = Fans call OFF
 Led ON = Fans call ON
 Flashing led = Fans paused after defrosting (see parameter F5)

- 12**  **DEFROST CALL ICON**
 Led OFF = Defrost call OFF
 Led ON = Defrost call ON
 Flashing led = Dripping in progress after defrosting (see parameter d7)

- 13**  **REAL TIME CLOCK ICON**
 Led OFF = Defrosting in real time clocks disabled
 Led ON = Defrosting in real time clocks enabled

- 14**  **ALARM PRESENT ICON**
 Led OFF = No alarm present
 Led ON = Alarm triggered and then resolved
 Flashing Led = Alarm present

- 15**  **DECIMAL POINT** (flashing in night mode)

- 16**  **AUXILIARY** (show AUX relay state, if AU1 = +/-2 or +/-3)

5.4

COMBINATION OF KEYS

**1ST LEVEL PROGRAMMING**

If pressed simultaneously for more than 3 seconds they enable access to first level programming menu.

EXIT FROM PROGRAMMING

If pressed simultaneously for more than 3 seconds within any programming menu, they save the settings made exiting the same menu.

**2ND LEVEL PROGRAMMING**

If pressed simultaneously for more than 3 seconds, they enable access to second level programming menu. Entering this menu puts it in stand-by.

**3RD LEVEL PROGRAMMING****(EEV parameters)**

If pressed simultaneously for more than 3 seconds, they enable access to third level programming menu. Entering this menu puts it in stand-by.

**QUICK VARIABLES VIEWING MENU****(READ ONLY)**

If pressed simultaneously for more than 3 seconds, they enable access to quick variables viewing menu.

From inside this menu the up and down arrows allow you to view the label and the variables.

By pressing the Set key, the label and its value are displayed alternately.

When you view the value of the current label you exit value viewing to the label by pressing the up or down arrows.

You exit this menu automatically after 2 minutes of keyboard inactivity or by pressing arrow up + arrow down.

5.5

SETTING AND DISPLAY OF THE SET POINT

1. Press the "Set" key to view the current SET POINT value (temperature).
2. By holding down the "Set" key and pressing one of the (▲) or (▼) keys you can change the SET POINT value.

Release the "Set" key to go back to viewing the cold room temperature, any changes will be memorised automatically.

FIRST LEVEL PROGRAMMING (User level)

5.6

To access the first level configuration menu you must:

1. Simultaneously keep keys (▲) and (▼) pressed down for more than 3 seconds until the first programming variable appears on the display.
2. Release keys (▲) and (▼).
3. Select the variable to amend using key (▲) or key (▼).
4. After having selected the wanted variable it will be possible:
 - To display its setting by pressing the SET key.
 - To amend the setting by keeping the SET key pressed and press one of the (▲) or (▼) keys.

To exit the menu once the configuration values are set, simultaneously keep keys (▲) and (▼) pressed for a few seconds until the cell humidity value appears again.

Memorisation of the amendments made to the variables will happen automatically when exiting the configuration menu.

LIST OF FIRST LEVEL VARIABLES (User level)

5.7

VARIABLES	MEANING	VALUES	DEFAULT
r0	Temperature differential referred to the main set point. This is expressed in absolute value and defines the hysteresis of the temperature referred to as the SET POINT.	0,2 ÷ 10,0 °C	2,0 °C
d0	Interval for defrost (hours) With d0=0 and dFr=0 the Defrosting operations are excluded	0 ÷ 24 hours	4 hours
d2	Set point for the end of defrost. Defrost is not carried out if the temperature read by the defrost probe is greater than the value of d2. (If the probe is broken defrost is performed based on time)	-35 ÷ 45 °C	15°C
d3	Maximum defrost time (minutes)	1 ÷ 240 min	25 min
d7	Dripping time (minutes) At the end of defrosting, the compressor and the fans remain still for the d7 set time, the defrosting led on the front of the panel flashes.	0 ÷ 10 min	0 min
F5	Fans pause after defrosting (minutes) Enables keeping the fans still for an F5 time after dripping. This time starts from the end of dripping. If dripping is not set, at the end of defrosting the fans pause occurs directly.	0 ÷ 10 min	0 min
A1	Minimum temperature alarm The absolute temperature referred to the ambient probe below which, once the Ald delay time is over, the LOW temperature alarm is activated, which consists in activating the Buzzer (if included), with the entry EL which alternates with the temperature on the display screen and the flashing icon indicating the presence of the alarm. When the alarm is resolved the "alarm present" icon stays on (steady) indicating that the repair has been made until you press the UP key.	-45 ÷ (A2-1) °C	-45°C
A2	Maximum temperature alarm The absolute temperature referred to the ambient probe above which, once the Ald delay time is over, the HIGH temperature alarm is activated, which consists in activating the Buzzer (if included), with the entry EH which alternates with the temperature on the display screen and the flashing icon indicating the presence of the alarm. When the alarm is resolved the "alarm present" icon stays on (steady) indicating that the repair has been made until you press the UP key.	(A1+1) ÷ +45°C	+45°C
dFr	Enabling evaporator defrosting in real time With d0=0 and dFr=1 it is possible to set up to 6 real time defrosting episodes in a single day using parameters dF1...dF6	0 = disabled 1 = enabled	0

VARIABLES	MEANING	VALUES	DEFAULT
dF1 ... dF6	Programming evaporator defrosting times. It is possible to set up to 6 times for defrosting episodes. The time is in the HH.M format where HH represents the hour and M tens of minutes (Ex. 0=0 min; 1=10 min, etc.). The flashing period (.) indicates that a time is being viewed, and not a temperature.	00.0 ÷ 23.5	--
tdS	Day start time programming	00.0 ÷ 23.5	6,0
tdE	Day end time programming	00.0 ÷ 23.5	22,0

5.8

2nd LEVEL PROGRAMMING (Installer level)

To access second level programming, you must:

1. Simultaneously keep keys UP (▲), DOWN (▼) and COLD ROOM LIGHT pressed for more than 3 seconds.

When the first programming variable appears, the system automatically switches to stand-by.

2. Select the variable to amend using key (▲) or key (▼). After having selected the wanted variable it will be possible:
 - To display its setting by pressing the SET key.
 - Change its setting by holding down the SET button and pressing one of the (▲) or (▼) keys.
3. Once the configuration of the values has been set, to exit the menu press (▲) and (▼). Keep them simultaneously pressed for a few seconds, until the temperature value appears.

Memorisation of the amendments made to the variables will happen automatically when exiting the configuration menu.

Press the STAND-BY key to enable electronic control.

5.9

LIST OF 2nd LEVEL VARIABLES (Installer level)

VARIABLES	MEANING	VALUES	DEFAULT
F3	Fans status with compressor off	0 = Fans in continuous start 1 = Fans running only when the compressor is running 2 = Fans DISABLED	1
F4	Fans pause during defrosting	0 = Fans working during defrosting 1 = Fans not working during defrosting	1
F6	Evaporator fans activation for air recirculation. The fans activate for a time defined by F7 if they have not started working for the F6 time. If activation time coincides with the defrosting time, end of defrosting is awaited.	0 ÷ 240 min 0 = (function not activated)	0 min
F7	Evaporator fans duration for air recirculation. Fans working time for F6	0 ÷ 240 sec.	10 sec
dE	Probe included By excluding the evaporator probe defrosting will be performed cyclically with a period of d0 and will terminate when the time expires on d3.	0 = evaporator probe included 1 = evaporator probe not included	0
d1	Type of defrosting , at cycle inversion (hot gas) or resistance.	2 = Heater with temperature control 1 = with hot gas 0 = with resistance	0
dPo	Defrost at Power On	0 = disabled 1 = defrost at power-on (if possible)	0
dSE	Smart defrost	0 = disabled 1 = enabled	0

VARIABLES	MEANING	VALUES	DEFAULT
dSt	Smart defrost Setpoint (if dSE=1) The counting of the time between the defrost is incremented only if the compressor is ON and the evaporator temperature is less than dSt.	-30 ÷ 30 °C	1 °C
dFd	Display viewing during Defrost	0 = current temperature 1 = temperature at the start of the defrost 2 = "DEF"	1
Ad	Net address for connection to TeleNET supervision system or Modbus-RTU	0 ÷ 31 (with SEr=0) 1 ÷ 247 (with SEr=1)	0
SEr	RS-485 communication protocol	0 = TeleNET protocol 1 = Modbus-RTU protocol	0
Bdr	Modbus baudrate	0=300 baud 3=2400 baud 6=14400 baud 1=600 baud 4=4800 baud 7=19200 baud 2=1200 baud 5=9600 baud 8=38400 baud	5
Prt	Modbus parity check	0 = none 1 = even 2 = odd	0
Ald	Minimum and maximum temperature signalling and alarm display delay	1 ÷ 240 min	120 min
C1	Minimum amount of time between switch off and the next Time the compressor is switched on.	0 ÷ 15 min	0 min
CA1	Cold room sensor value correction	-10,0 ÷ +10,0 °C	0,0 °C
CE1	Operating time ON for the compressor in case of broken ambient probe (Emergency function). With CE1=0 the emergency function with an E0 error remains disabled, the compressor stays off and defrosting is inhibited to preserve the residual cold.	0 ÷ 240 min 0 = disabled	0
CE2	Operating time OFF for the compressor in case of broken ambient probe (Emergency function)	5 ÷ 240 min	5
doC	Compressor guarding time for the micro door , when the micro door opens the evaporator fans switch off and the compressor will continue operating for time of doC, then it will switch off.	0 ÷ 5 minutes	0
tdo	Re-insert compressor time after opening the door. When the micro door opens and the tdo time is up the normal operation of the control will be restored and the "open door" alarm (Ed) will be sound. If the door switch is closed and the light stays on for a longer time than tdo light cell alarm is signalled (E9). With tdo=0 the parameter is disabled.	0 ÷ 240 minutes 0 = disabled	0
Fst	FAN blocking TEMPERATURE The fans do not switch on if the value of the temperature read by the evaporator probe is higher than the value of this parameter. The block is deactivated when the evaporator probe is disabled or presents an error.	-45 ÷ +45°C	+45°C
Fd	Differential for Fst	1 ÷ +10°C	2°C
LSE	Minimum value attributable to setpoint.	-45 ÷ (HSE-1) °C	-45 °C
HSE	Maximum value attributable to setpoint.	(LSE+1) ÷ +45°C	+45 °C

VARIABLES	MEANING	VALUES	DEFAULT
AU1	Auxiliary/alarm relay 1 control	-6 (NC) = relay de-energized during stand-by. -5 (NC) = Contact for casing element control (AUX relay closed with compressor output inactive). This output also remains active when the QE is in STAND-BY. -4 (NC) = pump down function (see CHAP 5.23). -3 (NC) = automatic auxiliary relay managed by StA temperature setting with 2°C differential. -2 (NC) = manual auxiliary relay controlled via AUX key. -1 (NC) = alarm relay. 0 = relay deactivated. 1 (NO) = alarm relay. 2 (NO) = manual auxiliary relay controlled via AUX key. 3 (NO) = automatic auxiliary relay managed by StA temperature setting with 2°C differential. 4 (NO) = pump down function (see CHAP 5.23). 5 (NO) = free voltage contact for condensing unit (AUX relay and compressor relay in parallel). 6 (NO) = relay excited during stand-by.	-1
StA	Temperature setting for auxiliary relay	-45 ÷ +45°C	0 °C
nSC	Correction factor for the SET button during night operation (energy saving) (with In1 or In2 = 8 o -8) During night operation the control set is: Set Control = Set + nSC In night mode decimal point flashes.	-20,0 ÷ +20,0 °C	0,0 °C
In1	Digital input DI1 and activation status setting.	8 = Night mode digital input (energy saving, N.O.) 7 = Stop defrosting remotely (N.O.) (reads rising edge of impulse) 6 = Start defrosting remotely (N.O.) (reads rising edge of impulse) 5 = Stand-by remotely (N.O.) (In order to indicate Stand-By mode, the display shows 'In5' alternating with the current view) 4 = Pump-down pressure switch (N.O.) 3 = Man-in-room alarm (N.O.) 2 = Compressor protection (N.O.) 1 = Door switch (N.O.) 0 = disabled -1 = Door switch (N.C.) -2 = Compressor protection (N.C.) -3 = Man-in-room alarm (N.C.) -4 = Pump-down pressure switch (N.C.) -5 = Stand-by remotely (N.C.) (In order to indicate Stand-By mode, the display shows 'In5' alternating with the current view) -6 = Start defrosting remotely (N.C.) (reads falling edge of impulse) -7 = Stop defrosting remotely (N.C.) (reads falling edge of impulse) -8 = Night mode digital input (energy saving, N.C.)	2
In2	Digital input DI2 and activation status setting.	- Same legend of values of In1 -	1
bEE	Buzzer enable	0 = disabled 1 = enabled	1

VARIABLES	MEANING	VALUES	DEFAULT
P1	Password: type of protection (active when PA is different from 0).	0 = displays only the set point and allows you to silence the alarms 1 = displays the set point, allows you to silence the alarms, + defrost + light + AUX key + menu with read-only access to the variables 2 = access blocks in programming for levels 1 and 2 and 3 (all other functions are allowed) 3 = access blocks in programming for levels 2 and 3 (all other functions are allowed) 4 = access blocks in programming for level 3 (all other functions are allowed)	3
PA	Password (see P1 for the type of protection)	0 ÷ 999 0 = deactivated function	0
Yr	Set the year	0 ÷ 99	
Mo	Set the month	1 ÷ 12	
dy	Set the day	1 ÷ 31	
Hr	Set the time	0 ÷ 23	
min	Set the minutes	0 ÷ 59	
reL	release software	read only	read only

5.10

3rd LEVEL PROGRAMMING (EEV PARAMETERS)

To access third level programming, you must:

1. Simultaneously keep keys UP (▲) and STAND.BY pressed for more than 3 seconds.

When the first programming variable appears, the system automatically switches to stand-by.

2. Select the variable to amend using key (▲) or key (▼). After having selected the wanted variable it will be possible:

- To display its setting by pressing the SET key.
- To amend the setting by keeping the SET key pressed down, and press one of the (▲) or (▼) keys.

3. Once the configuration of the values has been set, to exit the menu press (▲) and (▼). Keep them simultaneously pressed for a few seconds, until the temperature value appears.

Memorisation of the amendments made to the variables will happen automatically when exiting the configuration menu.

Press the STAND-BY key to enable electronic control.

5.11

LIST OF 3rd LEVEL VARIABLES (EEV PARAMETERS)

VARIABLES	MEANING	VALUES	DEFAULT
ESH	Overheating set point.	0,1 ÷ +25.0 °C	6.0°C
EEV	<p>Electronic valve EEV management With EEV=0 all controls and relative alerts are disabled. Relative errors for probe S4 (Extraction temperature) and S5 (Evaporation pressure) are also disabled and excluded</p> <p>The settings from 1 to 4 load default values in the ECt, EPb, Etl, Etd, ELS variables</p> <p>When you exit programming if the selected value for EEV is different from the one that was previously memorised, the relative defaults for this selection will be loaded.</p> <p>Pressing only the Set key to see the current value for EEV will not load the defaults.</p>	<p>0 = disabled 1 = EEV control (default 1) 2 = EEV control (default 2) 3 = EEV control (default 3) 4 = EEV control (default 4) 5 = EEV control (default 5)</p>	1
ErE	<p>Type of refrigerant GAS employed. Setting this parameter is essential for correct operation.</p>	<p>0 = R404 11 = R449A 1 = R134 12 = R290 2 = R22 13 = R32 3 = R407A 14 = R448A 4 = R407F 15 = R452A 5 = R407H 16 = R600 6 = R410A 17 = R600A 7 = R450A 18 = R1270 8 = R507 19 = R1234ze 9 = R513A 20 = R23 10 = R744(CO2) 21 = R717(NH3) 22 = R454C</p>	0
ECt	<p>Cycle time This represents the sum of EEV valve opening / closing cycle times. This is used to calculate the EEV opening and closing times.</p> <p>Example: if the EEV valve must be opened by 30% we will have: EEV valve opening time = ECt* 30/100 EEV valve closing time = ECt * (100-30)/100</p>	1 ÷ 20 seconds	6 sec
EPb	Proportional band (gain) PID overheating adjustment.	1 ÷ 100%	15%
Etl	Integral time PID overheating adjustment algorithm	0 ÷ 500 sec	100 sec
Etd	Derivative time PID overheating adjustment algorithm	0.0 ÷ 10.0 sec	2.0 sec

VARIABLES	MEANING	VALUES	DEFAULT
EOE	Percentage of the EEV valve opening in case of error with probes S4 or S5. This function allows you to continue with the adjustment, although not in an optimal fashion, in case the adjustment probes breakdown.	0 ÷ 100%	50%
ESO	During the Start phase the EEV valve opens as far as the ESO percentage and for the ESt time	0 ÷ 100%	85%
ESt	During the Start phase. In this phase the MOP, LOP, LSH alarms are disabled.	0 ÷ Edt tens of seconds	6 tens of seconds
EdO	After Defrost the EEV valve opens as far as EdO percentage for the Edt time.	0 ÷ 100%	100%
Edt	During the opening phase of the EdO valve after Defrost. In this phase the MOP, LOP, LSH alarms are disabled.	Est ÷ 250 tens of seconds	24 tens of seconds
EHO	Maximum percentage for the EEV valve opening: If the valve is oversized this variable allows you to limit the maximum opening and the set percentage.	0 ÷ 100%	100%
EPP	Type of pressure transducer (S5): set the type of transducer used to detect the Evaporation pressure (S5)	0 = 4÷20mA-type pressure transducer connected to the instrument 1 = ratiometric 0-5V-type pressure transducer connected to the instrument	0
EP4	Pressure (bar) corresponding to 4mA or to 0V Referred to the Evaporation pressure probe (S5).	-1.0 ÷ EP2 Bar	0.0
EP2	Pressure (bar) corresponding to 20mA or to 5V Referred to the Evaporation pressure probe (S5).	EP4 ÷ 90.0 Bar	12.0
CA4	Calibration of the Extraction temperature transducer (S4)	-10.0 ÷ +10.0 °C	0,0
CA5	Calibration of the Evaporation pressure transducer (S5)	-10,0 ÷ +10,0 Bar	0,0
LSH	LSH threshold (Low overheating temperature) Overheating values that are too low can cause liquid to return to the compressor or strong oscillations. Below the LSH value the ELS protection intervenes and acts by increasing the PID speed when closing the valve to reach the set overheating set.	0,0 ÷ Set SH °C	2,0 °C
ELS	LSH protection If enabled, when tSH < LSH the integration time for the PID is set based on the ELS selection from 1 to 7. The setting of 1 is the setting that generates a quicker closing. When this protection is entered the SHd count for LSH alarm activation will begin. THE LSH PROTECTION HAS PRIORITY OVER THE LOP PROTECTION. LSH PROTECTION IS NOT ACTIVATED. DURING THE START PHASE (ESt TIME), DURING THE DEFROST OR POST-DEFROST PHASE (Edt TIME).	0 = disables the protection LSH and relative LSH alarm alert 1 = 5% Etl 2 = 10% Etl 3 = 15% Etl 4 = 20% Etl 5 = 25% Etl 6 = 30% Etl 7 = 35% Etl 8 = 50% Etl 9 = 100% Etl (no correction and only the LSH alarm is active)	2
SHd	Delay in activating the LSH alarm: the LSH overheating alarm is signalled only after it has been active for the SHd time. In case of an LSH alarm, the valve closing is nevertheless instantaneous. The alarm is self-restoring and stops when tSH ≥ LSH With an active alarm, you have: - Flashing LSH written on the display screen - Buzzer	0 ÷ 240 tens of seconds	30

VARIABLES	MEANING	VALUES	DEFAULT
MOP	MOP threshold (Maximum saturated evaporation Temperature referred to the sensor S5) This represents the maximum evaporation pressure, expressed in saturated degrees, and activates the MOP protection when it is exceeded (EMO parameter). If the MOP kicks in the control will close the valve gradually to limit the evaporation temperature and avoid the compressor from stopping for thermal protection.	$(LOP+1) \div +45^{\circ}\text{C}$	+45°C
EMO	MOP protection (active with $tS5 > MOP$) With MOP protection on the valve abandons its control PID and at any other cycle time it closes as established by the EMO percentage starting from the opening percentage of the abandoned PID. When this protection is entered the MOd count for MOP alarm activation will begin. THE MOP PROTECTION IS NOT ACTIVATED DURING THE START PHASE (Est TIME), DURING THE DEFROST OR POST-DEFROST PHASE (Edt TIME)	0 = disables the MOP protection and relative MOP alarm alert $0 \div 100\%$	0
MOd	Delay in activating the MOP alarm: the MOP alarm is signalled only once the MOP protection has been active for the MOd time. The alarm is self-restoring when " Temp.S5 " \leq MOP With an active alarm, you have: - Flashing MOP written on the display screen - Buzzer	$0 \div 240$ tens of seconds	60
LOP	LOP threshold (Minimum saturated evaporation Temperature referred to the sensor S5) This represents the minimum evaporation pressure, expressed in saturated degrees, and activates the LOP protection when it falls below this value. In case of LOP the control opens the valve to avoid the compressor from stopping due to low pressure (mechanical pressure switch).	$-45^{\circ}\text{C} \div (MOP-1)$	-45°C
ELO	LOP protection (active with $tS5 > LOP$) With LOP protection on the valve abandons its control PID and at any other cycle time it opens as established by the ELO percentage starting from the opening percentage of the abandoned PID. When this protection is entered the LOd count for LOP alarm activation will begin. THE LSH PROTECTION HAS PRIORITY OVER THE LOP PROTECTION THE LOP PROTECTION IS NOT ACTIVATED DURING THE START PHASE (Est TIME), DURING THE DEFROST OR POST-DEFROST PHASE (Edt TIME)	0 = disables the LOP protection and relative LOP alarm alert $0 \div 100\%$	0
LOd	Delay in activating the LOP alarm: the LOP alarm is signalled only once the LOP protection has been active for the amount of the LOd time. The alarm is self-restoring when " Temp.S5 " \geq LOP With an active alarm, you have: - Flashing LOP written on the display screen - Buzzer	$0 \div 240$ tens of seconds	30

Note: all calculation times for the LSH, MOP, LOP alarms are reset when adjustment is complete OR DURING THE START PHASE (Est TIME), DURING THE DEFROST OR POST-DEFROST PHASE (Edt TIME).

LOADING DEFAULT SETTINGS BASED ON THE EEV VARIABLE:

5.12

	EEV = 1 PEGO DEFAULT	EEV = 2 (TN COLD ROOM or BENCH REFRIGERATOR control with built-in compressor)	EEV = 3 (BT COLD ROOM or BENCH REFRIGERATOR control with built-in compressor)	EEV = 4 (control of COLD ROOM or BENCH REFRIGERATOR, DUCTED TN)	EEV = 5 (control of COLD ROOM or BENCH REFRIGERATOR, DUCTED BT)
ESH	6 °C	6 °C	6 °C	11 °C	11 °C
EPb	15 %	15 %	15 %	15 %	15 %
Etl	100 sec	100 sec	100 sec	150 sec	150 sec
Etd	2 sec	2 sec	2 sec	5 sec	5 sec
LSH	2 °C	2 °C	2 °C	5 °C	5 °C
ELS	2	2	2	2	2
MOP	+45 °C	5 °C	-15 °C	+5 °C	-15 °C
EMO	0	5	5	5	5
LOP	-45 °C	-25 °C	-45 °C	0	0
ELO	0	15	15	0	0

TEMPERATURE TABLE FOR REFRIGERANT FLUIDS

5.13

The following table shows the evaporation temperature limits (tS5, see chapter 5.15) according to the type of refrigerant fluid (ErE parameter).

Parameter ErE	Code	Temperature range	Parameter ErE	Code	Temperature range
0	R404	-50 ÷ 70 °C	11	R449A	-50 ÷ 70 °C
1	R134A	-50 ÷ 70 °C	12	R290	-50 ÷ 70 °C
2	R22	-50 ÷ 70 °C	13	R32	-50 ÷ 70 °C
3	R407A	-50 ÷ 70 °C	14	R448A	-50 ÷ 70 °C
4	R407F	-50 ÷ 70 °C	15	R452A	-50 ÷ 70 °C
5	R407H	-50 ÷ 70 °C	16	R600	-20 ÷ 70 °C
6	R410A	-50 ÷ 70 °C	17	R600A	-30 ÷ 70 °C
7	R450A	-40 ÷ 70 °C	18	R1270	-50 ÷ 70 °C
8	R507	-50 ÷ 70 °C	19	R1234ZE	-30 ÷ 70 °C
9	R513A	-45 ÷ 70 °C	20	R23	-50 ÷ 25 °C
10	R744 (CO2)	-50 ÷ 40 °C	21	R717 (NH3)	-50 ÷ 70 °C
			22	R454C	-50 ÷ 70 °C

5.14

QUICK VARIABLES VIEWING MENU (READ ONLY)

During the start-up of the system, it may be useful to be able to easily check the reading of the various probes or of some values, to verify or optimize the process.

To access quick variables viewing menu, keep the DOWN (▼) and STAND-BY keys pressed for more than 3 seconds.

From inside this menu the up or down arrows allow you to view the label and the variables.

By pressing the SET key the label and its value are displayed alternately. (To make the reading easier press the set key to switch from label to value: it is not necessary to keep the set key pressed down).

When you view the value of the current label you exit value viewing to the label by pressing the up or down arrows.

You exit this menu automatically after 2 minutes of keyboard inactivity or by pressing arrow up + arrow down.

5.15

LIST OF VARIABLES QUICK VIEWING MENU (READ ONLY)

VARIABLES	MEANING	VALUES
tS0	View Ambient Temperature probe (S0)	(read only) °C
tS1	View Defrost Temperature probe (S1)	(read only) °C
tS4	View Extraction Temperature probe (S4)	(read only) °C
tS5	View Evaporation Temperature probe (S5)	(read only) °C
PS5	View Evaporation Pressure probe (S5)	(read only) Bar
tSH	View Overheating temperature $tSH = tS4 - tS5$	(read only) °C
oEV	Percentage of EEV valve opening	(read only) %

THERMOSTAT OPERATING MODE

5.16

COLD CALL MODE.

The DO1 output is activated when the temperature measured by the Ambient probe reaches or exceeds the SET POINT+r0 value and stays active until the temperature falls below the SET POINT.

This way the DO1 output mode is coordinated with the chill call icon switching on.

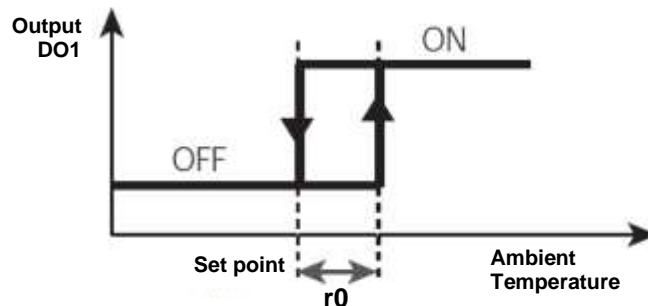

PASSWOD FUNCTION

5.17

The password function activates by setting a value different from 0 for parameter PA. See parameter P1 for the different protection levels.

Protection is enabled automatically after approx. 2 minutes of inactivity on the keyboard.

The digits 000 appear on the display screen. Use the up/down keys to change the number and the SET key to confirm it.

The mask to enter the password 000 disappears if you do not use the keyboard within 2 minutes.

If password is forgotten use the universal number 100.

EMERGENCY OPERATION IN THE EVENT OF AN E0 ERROR
(AMBIENT PROBE FAULT)

5.18

This safety mode guarantees the compressor will operate even if the ambient probe is not working (error E0). With probe error E0 and CE1 other than 0, the compressor works in work pause mode, with compressor ON for time of CE1 and OFF for time of CE2.

With CE1>0, when error E0 occurs defrosting will be managed as in the normal mode of operation.

With CE1=0, the emergency operation with an E0 error stays disabled: the compressor stays off and defrosting is inhibited to preserve the residual cold.

Eliminate the cause of error E0 as soon as possible and reactivate normal control operations to correctly adjust the temperature.

MANUAL DEFROST ACTIVATION

5.19

To activate defrost simply press the DOWN key for more than 3 seconds; this will activate the relay for resistances. Defrosting is not activated if conditions for activation are not met (the set temperature to terminate defrosting (d2), is lower than the temperature detected by the evaporator probe).

Defrosting will terminate when the defrosting temperature has been reached (d2) or for the maximum duration of defrost (d3) or when terminate defrost is forced manually (terminate defrost key or digital input).

5.20**MANUAL FORCING OF END DEFROST**

When defrost is in progress press the DOWN button for 3 seconds to force defrost in progress to terminate.

When terminating defrost manually the drip phase is also skipped.

5.21**DEFROST WITH HEATER AND TEMPERATURE CONTROL**

Set the parameter d1 = 2 for the management of heater defrost by time with temperature control. During the defrost, the output is activated when the evaporator's temperatures are lower than d2. Defrost stops after d3 minutes. It allows energy saving and a better defrost process.

5.22**HOT GAS DEFROST**

Set parameter d1 = 1 for managing cycle inversion defrosting.

The compressor relay and the defrosting relay are activated for the entire defrosting phase (defrost).

For the correct management of the plant, it will be the responsibility of the installer to use the defrost output, that must allow the opening of the cycle inversion solenoid valve and the closing of the liquid solenoid valve.

For the capillary plants (without thermostatic valve) it is sufficient to control the cycle inversion electro valve using the defrosting relay control (defrost).

5.23**VIEW TEMPERATURE AMBIENT AFTER DEFROSTING**

After defrosting the display screen will continue to display the last value for the ambient temperature read prior to defrost, for 1 minute.

5.24**PUMP DOWN FUNCTION**

Setting the parameter AU1 = 4 or -4 activates the compressor stop function in pump down.

The digital input configured as pump-down input (In1 or In2 = 4 or -4) constitutes the pressure switch input and directly manages the compressor output.

The AUX relay becomes the evaporator solenoid call and is managed by the cold thermostat call which also drives the EEV solenoid output.

CHAPTER 6: OPTIONS

TELENET MONITORING AND SUPERVISION SYSTEM

6.1

To connect the panel in a **TeleNET** network, follow the diagram below. Refer to **TeleNET** user manual for instrument configuration.

WARNING: During configuration, at entry "Module" select "Instrument ECP200EEV".

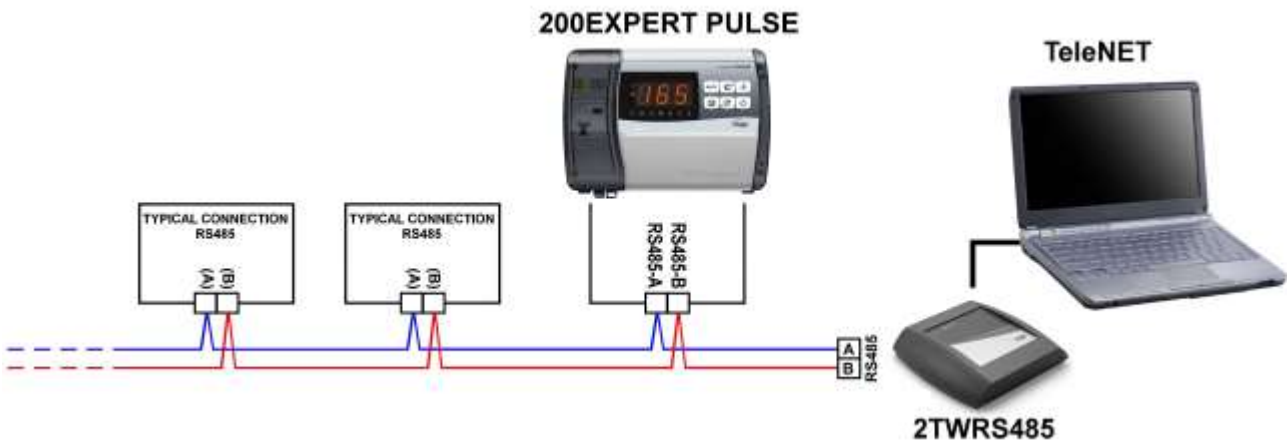

NET CONFIGURATION WITH MODBUS-RTU PROTOCOL

6.2

To connect the panel in an **RS485** network with **Modbus-RTU** protocol, follow the diagram below.

Refer to MODBUS-RTU_ECP200EEV user manual (available on Pego web site) for MODBUS-RTU communication protocol specification.

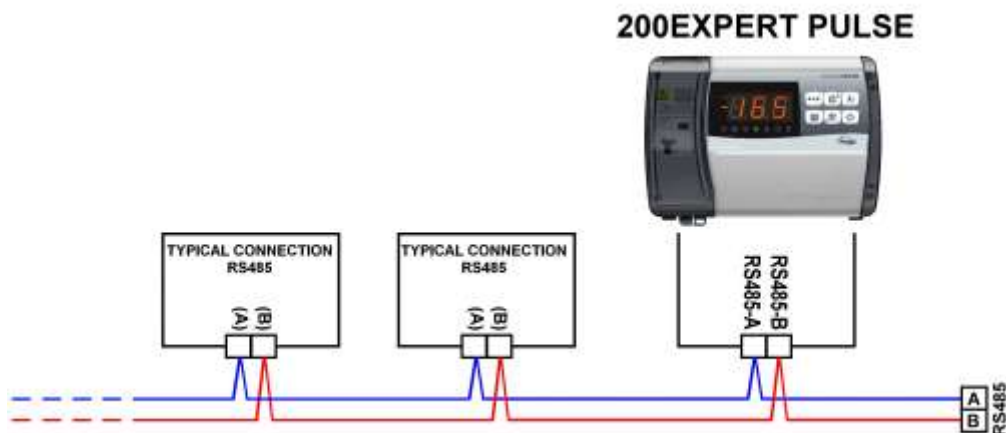

CHAPTER 7: DIAGNOSTICS

7.1

TROUBLESHOOTING

In case of anomaly, the **ECP200 EXPERT EEV** controller will alert the operator through the alarm codes displayed on the screen and with an acoustic signal emitted by a buzzer (if included).

The acoustic alarm can be switched off by pressing the UP key (the error code remains) and can be reactivated by pressing the SET key.

If an alarm condition arises, one of the following messages will appear on the display screen:

ALARM CODE	POSSIBLE CAUSE	OPERATIONS TO BE PERFORMED
E0	Functional anomaly of the ambient probe (S0)	<ul style="list-style-type: none"> • Check that cold room temperature sensor is working properly • If the problem persists replace the sensor
E1	Functional anomaly of the defrosting probe (S1) (In this case any defrosting will last for time established by d3).	<ul style="list-style-type: none"> • Check that cold room temperature sensor is working properly • If the problem persists replace the sensor
E4	Functional anomaly of the Extraction temperature probe (S4).	<ul style="list-style-type: none"> • Check that Extraction temperature probe is working properly
E5	Functional anomaly of the Evaporation Pressure probe (S5).	<ul style="list-style-type: none"> • Check that Evaporation Pressure probe is working properly
EE	Eeprom alarm An error has been found in the EEPROM memory. (All of the outputs have been deactivated except for the alarms, if configured).	<ul style="list-style-type: none"> • Switch unit off and back on
E6	Low battery alarm ; the control will work for at least 20 more days, after which time, if there is no longer a power supply to the panel the time setting will be lost.	
E8	Man in cold room alarm The man in cold room alarm button was pressed from inside the cold room to signal a hazardous situation.	<ul style="list-style-type: none"> • Reset the alarm input inside the cold room
E9	Alarm cold room light. Turning on the light with the key, spent the tdo time the alarm E9 goes off. If it is silenced and is not turned off the light, after a new time tdo, the alarm recurs.	<ul style="list-style-type: none"> • Turn off the cold room light
Ec	Insert compressor protection (ex. Thermal protection or max. pressure switch). (All of the outputs have been deactivated except for the alarm, if configured).	<ul style="list-style-type: none"> • Check that compressor is working properly • Check compressor absorption • If the problem persists contact the technical assistance service
Ed	Door open alarm. When the micro door opens and the tdo time is up the normal operation of the control will be restored and the "open door" alarm (Ed) will be sound.	<ul style="list-style-type: none"> • Check door switch status • Check door switch connections • If the problem persists contact the technical assistance service

EL	Minimum temperature alarm The words EL flash alternately with the temperature (See parameter A1)	<ul style="list-style-type: none"> • Check that the compressor is working properly. • Sensor not reading temperature properly or compressor start/stop control not working.
EH	Maximum temperature alarm. The words EH flash alternately with the temperature (See parameter A2)	<ul style="list-style-type: none"> • Check that the compressor is working properly. • Sensor not reading temperature properly or compressor start/stop control not working.
LSH	Low overheating temperature alarm	
MOP	Maximum saturated evaporation temperature alarm referred to sensor S4	
LOP	Minimum saturated evaporation temperature alarm referred to sensor S4	

APPENDICES

A.1

EU DECLARATION OF CONFORMITY

LA PRESENTE DICHIARAZIONE DI CONFORMITA' E' RILASCIATA SOTTO LA RESPONSABILITA' ESCLUSIVA DEL FABBRICANTE:
THIS DECLARATION OF CONFORMITY IS ISSUED UNDER THE EXCLUSIVE RESPONSIBILITY OF THE MANUFACTURER:



PEGO S.r.l. Via Piacentina 6/b, 45030 Occhiobello (RO) – Italy –
 Società soggetta all'attività di direzione e coordinamento di Castel S.r.l.

DENOMINAZIONE DEL PRODOTTO IN OGGETTO / DENOMINATION OF THE PRODUCT IN OBJECT

MOD.: ECP200 EXPERT EEV

IL PRODOTTO DI CUI SOPRA E' CONFORME ALLA PERTINENTE NORMATIVA DI ARMONIZZAZIONE DELL'UNIONE EUROPEA:
THE PRODUCT IS IN CONFORMITY WITH THE RELEVANT EUROPEAN HARMONIZATION LEGISLATION:

Direttiva Bassa Tensione (LVD): 2014/35/UE
Low voltage directive (LVD): 2014/35/EU

Direttiva EMC: 2014/30/UE
Electromagnetic compatibility (EMC): 2014/30/EU

LA CONFORMITA' PRESCRITTA DALLA DIRETTIVA E' GARANTITA DALL'ADEMPIMENTO A TUTTI GLI EFFETTI DELLE SEGUENTI NORME:
THE CONFORMITY REQUIRED BY THE DIRECTIVE IS GUARANTEED BY THE FULFILLMENT TO THE FOLLOWING STANDARDS:

Norme armonizzate: EN 60730-1:2016, EN 60730-2-9:2010, EN 61000-6-1:2007, EN 61000-6-3:2007
 European standards: EN 60730-1:2016, EN 60730-2-9:2010, EN 61000-6-1:2007, EN 61000-6-3:2007

IL PRODOTTO E' COSTITUITO PER ESSERE INCORPORATO IN UNA MACCHINA O PER ESSERE ASSEMBLATO CON ALTRI MACCHINARI PER COSTITUIRE UNA MACCHINA CONSIDERATE DALLA DIRETTIVA: 2006/42/CE "Direttiva Macchine".

THE PRODUCT HAS BEEN MANUFACTURED TO BE INCLUDED IN A MACHINE OR TO BE ASSEMBLED TOGETHER WITH OTHER MACHINERY TO COMPLETE A MACHINE ACCORDING TO DIRECTIVE: EC/2006/42 "Machinery Directive".

Firmato per nome e per conto di:
Signed for and on behalf of:

Luogo e Data del rilascio:
Place and Date of Release:

Occhiobello (RO), 01/01/2020

Pego S.r.l.
 Martino Villa
 Presidente

CONNECTIONS DIAGRAM

A.2

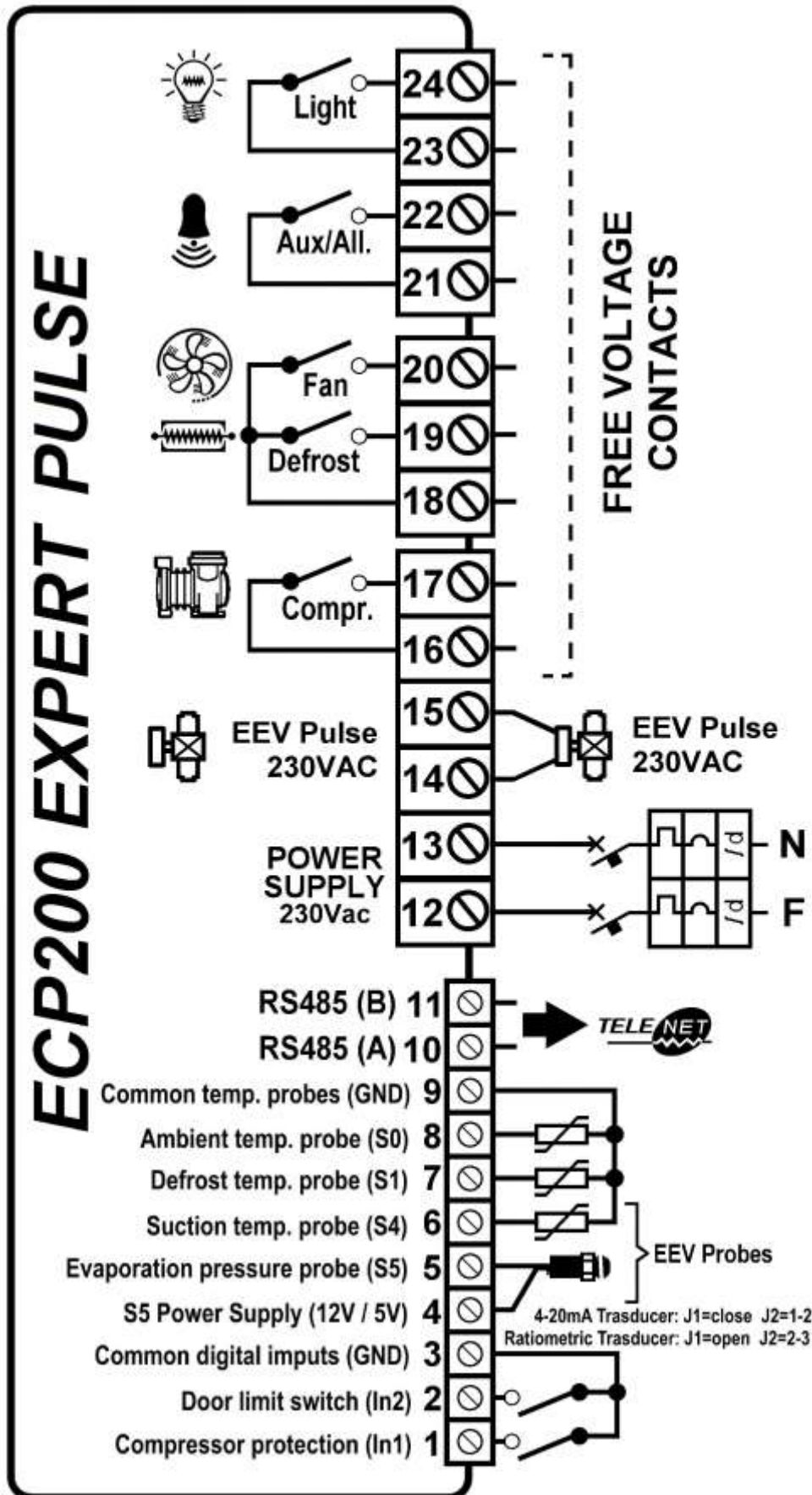

A.3

PART LIST

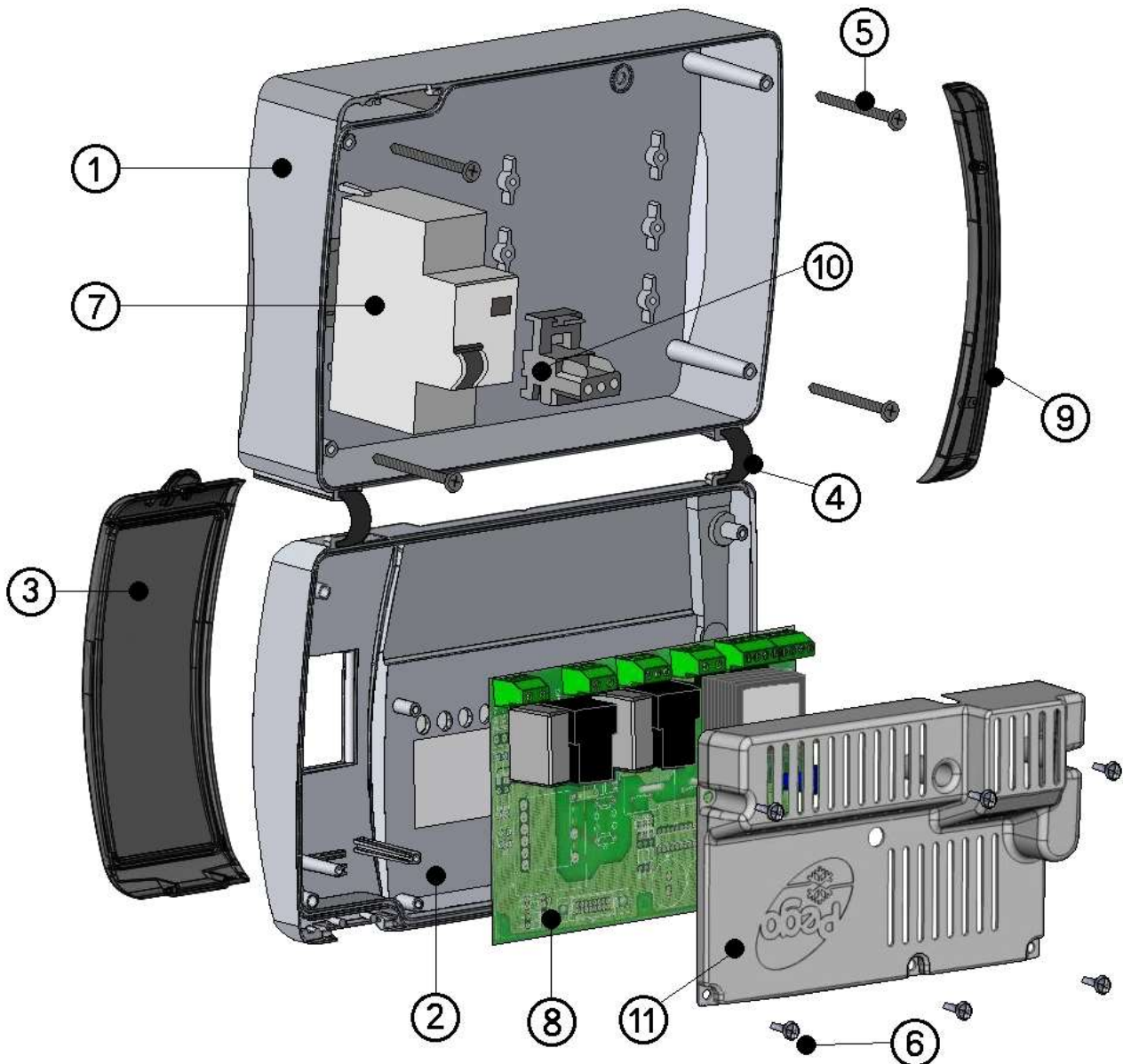

LEGEND

REF.	DESCRIPTION
1	BOX REAR IN ABS
2	BOX FRONT IN ABS
3	FRONT COVER IN TRANSPARENT POLYCARBONATE
4	BOX FRONT OPENING HINGE
5	BOX CLOSURE SCREWS
6	BOARD FIXING SCREWS
7	MAGNETO-THERMAL CUT-OUT / POWER BREAKER
8	CPU BOARD
9	POLYCARBONATE SCREW COVER
10	TERMINAL FOR EARTH CONNECTIONS
11	BOARD PROTECTION COVER



PEGO s.r.l.
Via Piacentina, 6/b 45030 Occhiobello ROVIGO - ITALY
Tel. +39 0425 762906
e-mail: info@pego.it – www.pego.it

AFTER-SALES ASSISTANCE SERVICE
Tel. +39 0425 762906 e-mail: tecnico@pego.it

Distributor: