

200SCH202HYP



User manual

ENGLISH

READ AND KEEP

TABLE OF CONTENTS

INTRODUCTION

Page 4 1.1 General information

CHAP. 1

DATA PROGRAMMING

Page 5 2.1 Control panel
 Page 5 2.2 Front keyboard
 Page 6 2.3 LED Display
 Page 7 2.4 General information
 Page 7 2.5 Symbols
 Page 7 2.6 Setting and set-point display
 Page 8 2.7 First level programming
 Page 8 2.8 List of first level parameters
 Page 10 2.9 Second level programming
 Page 10 2.10 List of second level parameters
 Page 15 2.11 HACCP alarm management
 Page 16 2.12 Switch-on
 Page 16 2.13 Manual defrost activation
 Page 16 2.14 Manually forced defrost stop
 Page 16 2.15 Hot gas defrosting
 Page 17 2.16 Defrost with thermostat-controlled heater
 Page 17 2.17 Display view during defrosting
 Page 17 2.18 Pump-down function
 Page 17 2.19 Day/night function
 Page 18 2.20 Password function
 Page 18 2.21 Emergency operation with faulty room sensor (E0)

CHAP. 2

OPTIONS

Page 19 3.1 TeleNET monitoring / supervision system
 Page 19 3.2 Network configuration with Modbus-RTU protocol

CHAP. 3

DIAGNOSTICS

Page 20 4.1 Diagnostics

CHAP. 4

ATTACHMENTS

Page 22 A.1 Wiring diagram 200SCH202HYP

CHAPTER 1: INTRODUCTION

GENERAL INFORMATION

1.1

APPLICATIONS:

- Cold room with single condensing unit.
- Complete control of static or ventilated refrigeration system, with off-cycle, electrical or hot gas defrosting with direct or pump-down compressor stop.

KEY FEATURES:

- Display and adjustment of the cell temperature with decimal point.
- Evaporator temperature display.
- System control (stand-by) activation/deactivation.
- System alarm signalling.
- Management of absolute or setpoint temperature alarm.
- LED signalling of the system status and large displays.
- Easy to use keyboard.
- Evaporator fan management.
- Air recirculation management (anti-stratification function).
- Real-time defrost with end-of-defrost probe.
- Automatic and manual defrost management (static, resistor, cycle reversal, thermostat resistors).
- Smart defrost (energy saving).
- Reduced set function (night set) with time scheduling.
- Management and direct or pump-down control of compressor unit.
- Cold room light activation with button on the panel or via door switch.
- Advanced HACCP function with detailed log of the last temperature alarm triggered and alarm history counter.

CHAPTER 2: DATA PROGRAMMING





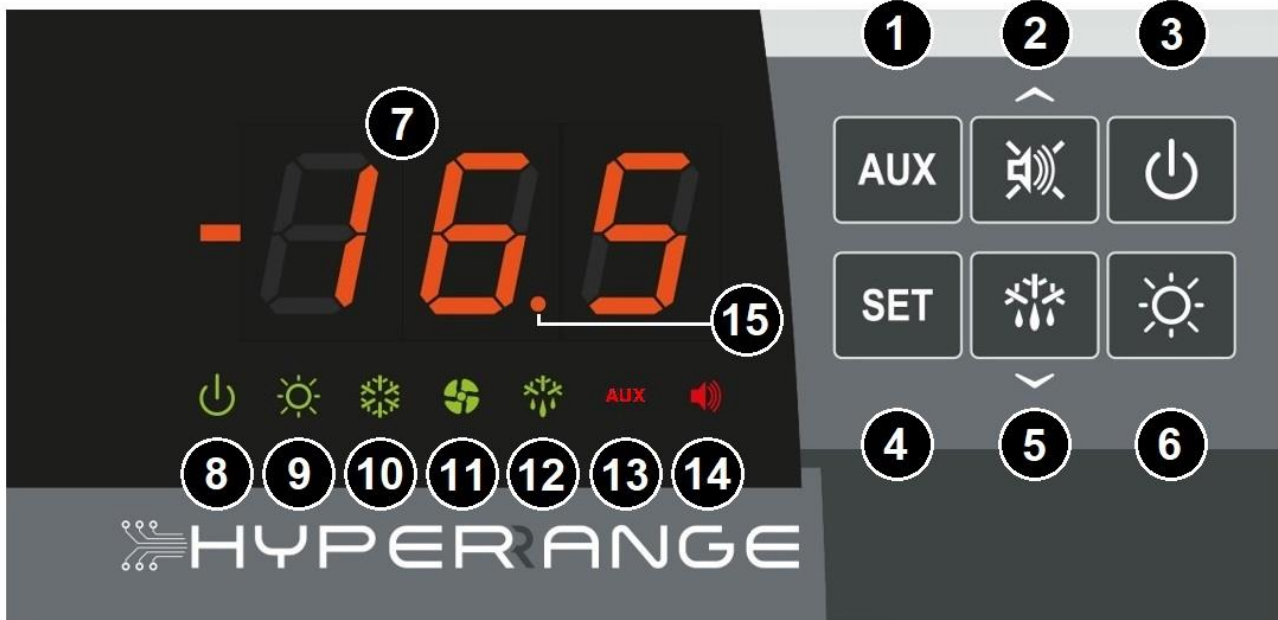

2.1

CONTROL PANEL





2.2

FRONT KEYBOARD

- 1**  **AUXILIARY RELAY CONTROL**
Manually controls the auxiliary relay if parameter DO*= 7 o -7;
The current date/time is displayed if pressed for several seconds.
- 2**  **UP / ALARM BUZZER MUTE**
HACCP menu access if pressed for several seconds.
If pressed once during a current alarm, the buzzer is muted.
If pressed once in case of an alarm reset, information is acquired and the alarm icon is switch off.
- 3**  **STAND-BY**
Enables/disables stand by.
The system is halted and the stand-by icon (8) flashes during stand-by.
- 4**  **AMBIENT TEMPERATURE SETTING**
If pressed for several seconds with button 2 in the HACCP menu, the HACCP alarms recorded are reset.
- 5**  **MANUAL DOWN/DEFROST**
If pressed for x second, manual defrost is enabled/disabled.
- 6**  **CELL LIGHT**
Switches the cold room light on/off.

7 AMBIENT TEMPERATURE/PARAMETER VALUES

8  **STAND-BY ICON**
 Led OFF = Panel off / no power supply.
 Led ON = Panel on and operating.
 Led flashing = Panel on and in stand-by (cold output, defrost, fans disabled).

9  **ROOM LIGHT / DOOR SWITCH INPUT ICON**
 Led OFF = Room light relay OFF / door switch not active or not configured.
 Led ON = Room light relay ON (manual).
 Led flashing = Room light relay ON for active door switch.

10  **COLD CALL ICON**
 Led OFF = Cold call OFF.
 Led ON = Cold call ON.
 Led flashing = Cold call ON but waiting for C1 delay.

11  **FAN CALL ICON**
 Led OFF = Fan call OFF.
 Led ON = Fan call ON.
 Flashing LED = Fans paused after defrosting (see parameter F5).

12  **DEFROST CALL ICON**
 Led OFF = Defrost call OFF.
 Led ON = Defrost call ON.
 Flashing LED = Dripping in progress after defrosting (see parameter d7).

13  **AUXILIARY RELAY ICON** (if parameter CO* = 7 or -7)
 Led OFF = Aux relay call OFF
 Led ON = Aux relay call ON

14  **ALARM PRESENCE ICON**
 Led OFF = No alarm.
 Led ON = Alarm triggered or reset (HACCP alarm saved).
 Led flashing = Alarm in progress.

15  **DECIMAL POINT**
 Flashing in night mode

2.4

GENERAL INFORMATION



For safety reasons of safety and for greater user friendliness, the **202 HYPERANGE** card has two programming levels; the first to configure the frequently modified **SETPOINT** parameters only, and the second for the programming and setting of general parameters relating to the various card operating modes.

It is not possible to access Level 2 programming directly from Level 1: you must exit the programming mode first.

2.5

SYMBOLS

For convenience we will indicate with the symbols:

- (▲) the UP key  is used to increase the value or mute/detect the alarm;
- (▼) the DOWN key  is used to decrease the value and for manual ON/OFF defrost.

2.6

SETTING AND SET-POINT DISPLAY

1. Press the **SET key** to display the current **SET-POINT** value (temperature).
2. Holding down the **SET key** and pressing one of the (▲) or (▼) keys changes the **SET-POINT** value.
3. Release the **SET key** to return to the cold room temperature display; the changes made will be automatically saved.

FIRST-LEVEL PROGRAMMING (User level)

2.7

To access the first level configuration menu you must:

1. Press and hold the (\blacktriangle) and (\blacktriangledown) keys simultaneously for a few seconds until the first programming variable appears on the display.
2. Release the (\blacktriangle) and (\blacktriangledown) keys.
3. Select the parameter to modify using the (\blacktriangle) or (\blacktriangledown) key.
4. When the parameter has been selected, it is possible to:
 - Display the setting by pressing the SET key.
 - Change the setting by holding down the SET key and pressing one of the (\blacktriangle) or (\blacktriangledown) keys.
5. When the configuration values have been set, you can exit the menu by pressing and holding the (\blacktriangle) and (\blacktriangledown) keys simultaneously for a few seconds until the ambient temperature reappears.

The changes to the parameters are saved automatically when you exit the configuration menu.

LIST OF LEVEL 1 VARIABLES (User level)

2.8

PAR	MEANING	VALUES	DEFAULT
r0	Temperature difference referred to the main SET-POINT.	0.2 ÷ 10.0 °C	2 °C
d0	Defrost interval (hours). If d0=0 and dFr=0, defrosting is excluded.	0 ÷ 24 hours	4 hours
dd2	Not used. Do not change the value of this parameter.		0
d21	Evaporator end-of-defrost setpoint. Defrosting is not performed if the temperature read by the defrosting probe is higher than the value d21 (in case of a faulty probe defrosting is performed on time).	-35 ÷ 45 °C	15 °C
d22	Not used. Do not change the value of this parameter.		15
d31	Maximum evaporator defrost duration (minutes)	1 ÷ 240 min	25 min
d32	Not used. Do not change the value of this parameter.		25
d7	Dripping duration (minutes). At the end of defrosting, the compressor and fans remain stationary for the set time d7, the defrosting LED on the front of the panel flashes.	0 ÷ 10 min	0 min
F5	Fan pause after defrosting (minutes). Fans are kept at standstill for a time F5 after dripping. This time is counted from the end of the dripping. If dripping is not enabled, the fan pause starts at the end of defrost.	0 ÷ 10 min	0 min

PAR	MEANING	VALUES	DEFAULT
A1	<p>Minimum temperature alarm If Ar = 0: Absolute minimum temperature for the room probe. If the ambient temperature falls below value A1, the low temperature alarm EL is triggered after the Ald delay time has elapsed and is saved in the HACCP menu. If Ar = 1: Alarm threshold for setpoint. If the ambient temperature falls below < Setpoint – A1 >, the low temperature alarm EL is triggered after the Ald delay time has elapsed and is saved in the HACCP menu. With the EL alarm active, the EL message is alternated with the temperature, the alarm relay, the buzzer (mute) and the alarm bell icon (flashing) are activated. When the set alarm conditions are resolved, the alarm signal is automatically cancelled. The alarm indicator light stays on to indicate that an alarm has been triggered and the event saved (see HACCP menu for display and reset of the temperature alarms triggered).</p>	<p>If Ar=0: -45 ÷ A2 °C</p> <p>If Ar=1: -45 ÷ 0 °C</p>	-45 °C
A2	<p>Maximum temperature alarm If Ar = 0: Absolute maximum temperature for the room probe. If the ambient temperature rises above value A2, the high temperature alarm EH is triggered after the Ald delay time has elapsed and is saved in the HACCP menu. If Ar = 1: Alarm threshold for setpoint. If the ambient temperature rises above < Setpoint – A2 >, the high temperature alarm EH is triggered after the Ald delay time has elapsed and is saved in the HACCP menu. With the EH alarm active, the EH message is alternated with the temperature, the alarm relay, the buzzer (mute) and the alarm bell icon (flashing) are activated. When the set alarm conditions are resolved, the alarm signal is automatically cancelled. The alarm indicator light stays on to indicate that an alarm has been triggered and the event saved (see HACCP menu for display and reset of the temperature alarms triggered).</p>	<p>If Ar=0: A1 ÷ +99 °C</p> <p>If Ar=1: 0 ÷ +99 °C</p>	+99 °C
Ar	Setpoint temperature alarms	0 = absolute alarms 1 = setpoint alarms	0
tE1	Evaporator probe temperature display (PRB. EV) (nothing is displayed if dE1 =1)	Temperature	Read-only
tE2	Not used.		---
tAn	Room probe temperature display (PRB AMB) (Nothing displayed if probe is in error mode)	Temperature	Read-only
tAu	Not used.		---
dFr	Enable real-time defrosting of evaporator. With d0=0 and dFr=1 it is possible to set up to 6 real-time defrosts over a day through the dF1...dF6 parameters.	0 = disabled 1 = enabled	0
dF1 ... dF6	Programming the evaporator defrost times. You can set up to 6 times for defrost. The defrosting depends on the settings of the dd2, d21, d22, d31 and d32 variables. The time is in the form HH.M where HH represents the hour and M the tens of minutes (Ex. 0=0 min; 1=10 min, etc.). The flashing dot (.) indicates that a time is displayed and not a temperature.	00.0 ÷ 23.5	--
tdS	Start of day phase	00:00 ÷ 23:59	06:00
tdE	End of day phase	00:00 ÷ 23:59	22:00

LEVEL 2 OF PROGRAMMING (Installer level)

2.9

1. To access the second programming level, press and hold the UP (▲), DOWN (▼) and LIGHT keys for a few seconds.
2. The system automatically switches to stand-by when the first programming parameter appears.
3. Select the parameter to modify using the (▲) or (▼) key. When the parameter has been selected, it is possible to:
 - Display the setting by pressing the SET key.
 - Change the setting by holding down the SET key and pressing one of the (▲) or (▼) keys.
4. When the configuration values have been set, you can exit the menu by pressing and holding the (▲) and (▼) keys simultaneously for a few seconds until the cold room temperature reappears.

The changes to the parameters are saved automatically when you exit the configuration menu.

5. Press the STAND-BY key to enable the electronic control.

LIST OF LEVEL 2 VARIABLES (Installer level)

2.10

PAR.	MEANING	VALUES	DEFAULT
nrE	Do not change the value of this parameter.		1
F3	Compressor off fan status	0 = Fans running continuously. 1 = Fans operating only with the compressor running. 2 = Fans disabled.	1
F4	Fan pause during defrosting	0 = Fans operating during defrosting. 1 = Fans not working during defrosting.	1
F6	Evaporator fans activation for air recirculation. The fans are activated for a time defined by F7 if they have not entered into operation for time F6. If the activation time coincides with the defrosting phase, the end of defrosting is completed anyway.	0 ÷ 240 min 0 = (function not enabled)	0 min
F7	Duration of the evaporator fans activation for air circulation. Fan operating time for F6.	0 ÷ 240 sec	10 sec
dE1	Evaporator probe present By excluding the evaporator probe, defrosting occurs in cycles with period d0 or by real time clock and ends when time d31 elapses.	0 = evaporator probe 1 present 1 = evaporator probe 1 absent	0
dE2	Do not change the value of this parameter.		1
AUE	Do not change the value of this parameter.		0
d1	Type of defrost: reverse cycle (hot gas) or resistance.	3 = heater, thermostat 2 = hot gas with drip tray 1 = hot gas 0 = resistance	0
dPo	Defrost at start-up	0 = disabled 1 = defrost at start-up (if possible)	0
dSE	Intelligent defrosting	0 = disabled 1 = enabled	0

PAR.	MEANING	VALUES	DEFAULT
dSt	Smart defrost setpoint (if dSE=1). The time count between defrosts is only increased if the compressor is switched on and the evaporator temperature is less than dSt.	-30 ÷ 30 °C	1 °C
dFd	Display view when defrosting	0 = current ambient temperature. 1 = ambient temperature at the beginning of defrosting. 2 = "DEF"	1
Ald	Signalling delay time and display of minimum or maximum temperature alarm.	0 ÷ 240 min	120 min
AtE	Temperature alarm enabling	0 = always enabled. 1 = disabled in case of stand-by. 2 = disabled if door switch active. 3 = disabled if stand-by or door switch active.	0
C1	Minimum time between shut-down and next compressor power on.	0 ÷ 15 min	0 min
CE1	Compressor ON operating time in case of faulty ambient probe (emergency operation). With CE1=0, the emergency operation remains disabled in the presence of error E0: the compressor remains off and defrosting is switched off to preserve the residual cold.	0 ÷ 240 min 0 = disabled	0 min
CE2	Compressor OFF operating time in case of faulty ambient probe (emergency operation).	5 ÷ 240 min	5 min
CA1	Ambient probe value correction	-10.0 ÷ +10.0 °C	0.0 °C
CA2	Not used. Do not change the value of this parameter.		0.0
doC	Compressor safety time for door switch. When the door is opened, the evaporator fans shut down and the compressor will continue working for time doC, after which it will shut down. It will shut down afterwards.	0 ÷ 5 minutes	0
tdo	Compressor restart time after door opening. When the door is opened and the tdo time has elapsed, normal control operation is resumed; the open-door alarm (Ed) is displayed. With tdo=0 the parameter is disabled.	0 ÷ 240 min 0 = disabled	0
tLo	Signal delay time and cold room light alarm display. After the light is switched on with the LIGHT key and the tLo time has elapsed, the E9 alarm is triggered. If it is silenced and the light is not switched off upon the new expiry of the time tLo, the E9 alarm reappears.	0 ÷ 240 min 0 = disabled	0
Fst	FAN blocking TEMPERATURE. The fans will remain stationary if the temperature value read by the evaporator probe is higher than the value of this parameter.	-45 ÷ +99°C	+99 °C
Fd	Differential for Fst	1 ÷ +10°C	2 °C
LSE	Minimum value attributable to the setpoint	-45 ÷ HSE °C	-45 °C

PAR.	MEANING	VALUES	DEFAULT
HSE	Maximum value attributable to the setpoint	LSE ÷ +99 °C	+99 °C
StA	Auxiliary relay temperature set	-45 ÷ +99°C	0
nSC	<p>Correction factor for the SET button during night operation (energy saving). During night operation, the control set is: Adjustment set = Set + nSc In night mode, the decimal point flashes.</p>	<p>0 = function disabled -20.0 ÷ +20.0 °C</p>	0
mOd	Do not change the value of this parameter.		0
In1	<p>DI1 digital input setting and activation status. (Do not change this setting)</p>	<p>9 = Defrost block with electromechanical pump-down (N.O.) 8 = Night input (energy saving) (N.O.) 7 = Pump-down pressure switch (N.O.) 6 = Stops defrosting remotely (N.O.) Reads rising edge of impulse. 5 = Starts defrosting remotely (N.O.) Reads rising edge of impulse. 4 = Remote standby (N.O.) The display shows 'Ino' alternating with the current display to indicate remote stand-by. 3 = Man in Cell alarm (N.O.) 2 = Door switch (N.O.) 1 = Compressor protection (N.O.) 0 = Disabled -1 = Compressor protection (N.C.) -2 = Micro-door (N.C.) -3 = Man in Cell Alarm (N.C.) -4 = Remote stand-by (N.C.) 'Ino' is displayed alternating with the current display to indicate remote stand-by. -5 = Starts defrosting remotely (N.C.) Reads falling edge of impulse. -6 = Stops defrosting remotely (N.O.) Reads falling edge of impulse. -7 = Pump-down pressure switch (N.C.) -8 = Night input (energy saving) (N.C.) -9 = Defrosting blocked with electromechanical pump-down (N.C.)</p>	1
In2	<p>DI2 digital input setting and activation status. (Do not change this setting)</p>	- Same key as In1 values -	2

PAR.	MEANING	VALUES	DEFAULT
In3	DI3 digital input setting and activation status. (Not considered if AUE is not equal to 0). (Do not change this setting)	- Same key as In1 values -	-9
DO1	Relay 1 management (Do not change this setting)	4 (NO) = Evaporator defrost heaters.	4
DO2	Relay 2 management (Do not change this setting)	1 (NO) = Compressor.	1
DO3	Relay 3 management (Do not change this setting)	2 (NO) = Evaporator fans.	2
DO4	Relay 4 management	-13 (NC) = Liquid solenoid (for hot gas defrost control). -12 (NC) = Heat output. -11 (NC) = Relay excited in night mode. -10 (NC) = Relay excited during stand-by. -9 (NC) = Pump down function (see ch. 5.20). -8 (NC) = Automatic auxiliary relay managed by temperature set StA with differential 2°C. -7 (NC) = Auxiliary manual relay controlled by AU KEY -6 (NC) = Alarm relay. -5 (NC) = Do not use. -4 (NC) = Evaporator defrost heaters. -3 (NC) = Cold room light (automatically activated with door open or man in cold room alarm E8). -2 (NC) = Evaporator fans. -1 (NC) = Compressor. 0 = Relay off. 1 (NO) = Compressor. 2 (NO) = Evaporator fans. 3 (NO) = Cold room light (automatically activated with door open or man in cold room alarm E8). 4 (NO) = Evaporator defrost heaters. 5 (NO) = Do not use. 6 (NO) = Alarm relay. 7 (NO) = Auxiliary manual relay controlled by AUX KEY 8 (NO) = Automatic auxiliary relay managed by temperature set StA with differential 2°C. 9 (NO) = Pump down function (see ch. 5.20). 10 (NO) = Relay excited during stand-by. 11 (NO) = Relay excited in night mode. 12 (NO) = Heat output (NO). 13 (NO) = Liquid solenoid (for hot gas defrost control).	-6
DO5	Relay 5 management	- Same key as DO4 values -	8
DO6	Relay 6 management (Do not change this setting)	3 (NO) = Cold room light (automatically activated with door open or man in cold room alarm E8).	3
bEE	Buzzer enabling	0 = disabled 1 = enabled	1

PAR.	MEANING	VALUES	DEFAULT
Ad	Network address for connection to the TeleNET or Modbus-RTU supervision system.	0 ÷ 31 (with SEr=0) 1 ÷ 247 (with SEr=1)	0
Ser	RS-485 communication protocol	0 = TeleNET Protocol 1 = Modbus-RTU protocol	0
Bdr	Modbus baud rate	0 = 300 baud 3 = 2400 baud 6 = 14400 baud 1 = 600 baud 4 = 4800 baud 7 = 19200baud 2 = 1200 baud 5 = 9600 baud 8 = 38400baud	5
Prt	Parity bit Modbus	0 = no parity 1 = even parity (even) 2 = odd parity (odd)	0
P1	Password: security type (active when PA is other than 0)	0 = only displays setpoint. 1 = displays set point, access to light and AUX keys. 2 = block access during programming. 3 = block access during second level programming.	3
PA	Password (see P1 for type of protection)	0 ÷ 999 0 = function disabled	0
Yr	Year setting	0 ÷ 99	22
Mo	Month setting	1 ÷ 12	1
dy	Day setting	1 ÷ 31	1
Hr	Time setting	0 ÷ 23	12
min	Minutes setting	0 ÷ 59	0
dEF	Default parameter setting	Press all the keys simultaneously for 20 seconds to reset the parameters to default.	-
reL	software release	Indicates the software version	read-only

2.11

HACCP ALARM MANAGEMENT

During a high or low temperature alarm, the display alternates the temperature display with the message **EH** or **EL**; the alarm relay, buzzer (mute) and alarm bell icon (flashing) are activated. When the alarm conditions have been resolved, the alarm messages are automatically cancelled (alarm relay disabled, buzzer muted and normal display restored). The alarm bell icon stays on to indicate that the EH or EL alarm has been triggered and the event saved (see HACCP menu for display and reset of the temperature alarms triggered). The start date, duration and maximum or minimum temperature reached of the last WH or EL event is recorded. Includes the count of the number of alarms triggered since the last alarm reset. Access the HACCP menu (press (▲) key for several seconds) to display the temperature alarm. The alarm saved can be reset in the menu by pressing the (▲) + SET keys simultaneously for several seconds. An audio signal confirms that the alarm has been cancelled. Exit the menu by waiting 10 seconds without pressing any keys or by pressing the up and down arrows at the same time.

The HACCP menu variables are read-only and as follows:

VARIABLES	MEANING	VALUES	DEFAULT
E##	Indicates the last temperature alarm triggered.	EH = high temperature alarm. EL = low temperature alarm. -- = no alarm triggered since last reset.	Read only
###	Peak temperature value reached during last Eh or EL alarm.	-45...+45°C --- = no alarm triggered since last reset	Read only
y##	Year last temperature alarm started.	y00 – y99 y-- = no alarm triggered since last reset.	Read only
M##	Month last temperature alarm started.	M01 – M12 M-- = no alarm triggered since last reset.	Read only
d##	Day last temperature alarm started.	d01 – d31 d-- = no alarm triggered since last reset.	Read only
h##	Hour last temperature alarm started.	h00 – h24 h-- = no alarm triggered since last reset.	Read only
m##	Minutes last temperature alarm started.	m00 – m59 m-- = no alarm triggered since last reset.	Read only
t##	Duration (hours) of last temperature alarm.	t00 – t99 t-- = no alarm triggered since last reset.	Read only
C##	Counter for the no. of temperature alarms triggered (this counter is incremented to detect whether any other events occurred previously since the data of the last temperature alarm event is stored). This counter is reset when the saved alarm is reset (press (▲) + SET key for 5 seconds). It is incremented every time a new temperature alarm occurs.	C00 – C99 C-- = no alarm triggered since last reset.	Read only

SWITCH-ON**2.12**

A sound is emitted for a few seconds when the electronic board is switched on and all the LED lights are illuminated on the display.

MANUAL DEFROST ACTIVATION**2.13**

To activate defrosting, just press the  keys for a few seconds - the heater relay will be activated when the right conditions are met.

Defrosting will end when the temperature of the end-of-defrost variable (d21) is reached or by maximum defrost duration (d31).

Exiting defrost is not activated if the set temperature of the end-of-defrost variable (d21) is lower than the temperature detected by the evaporator probe.

Manual defrosting is possible even if defrosting has been set in real-time clock.

MANUALLY FORCED END-OF-DEFROST**2.14**

When defrosting is in progress, pressing the  key for 3 seconds forces the end of defrosting.

HOT GAS DEFROSTING**2.15**

Set the parameter d1=1 for control hot gas defrosting.

All the compressor relays and the defrost relay are activated for the entire defrost phase.

For correct operation of the system, connect the hot-gas defrosting solenoid valve to terminal block X3, see the panel circuit diagram for correct wiring.

This will ensure that the liquid solenoid valve is closed during the defrost phase and the hot gas defrost cycle is activated.

With d1=2, the defrost relay remains activated even during dripping to ensure prolonged activation of the drip tray heater.

DEFROST WITH THERMOSTAT-CONTROLLED HEATER**2.16**

Set parameter d1=3 to manage the defrost with thermostat-controlled heaters within a time limit. During defrosting, the defrost output is activated if the evaporator temperature is less than the end-of-defrost threshold (d21). Defrosting ends after d31 minutes. This allows a better defrosting of the evaporator with consequent energy savings.

DISPLAY VIEW WHEN DEFROSTING**2.17**

During defrosting or for the minute after:

- if dFd=0, the display continues to show the current ambient temperature.
- if dFd=1, the display continues to show the last ambient temperature detected before starting the defrost.
- if dFd=2, the display shows the message "dEF".

PUMP DOWN FUNCTION**2.18**

Pump-down is controlled by electromechanics. In/3 input is configured = -9 (Defrosting blocked with electromechanical pump-down (N.C.)) in order to synchronise the compressor and defrost digital outputs. When the defrost phase is started either manually or automatically, the relevant digital output is only activated when the compressor has shut down. Defrost remains in stand-by when the compressor is active.

For the correct management of the pump-down function, connect the relevant pressure switch to the X3 terminal block - see the panel circuit diagram for the correct wiring.

DAY/NIGHT FUNCTION**2.19**

The day/night function is activated by setting the nSC parameter to a value other than 0. This allows for energy saving because the temperature setpoint can be varied in a specific time band.

During night function, the adjustment setpoint is:

$$\text{Adjustment set} = \text{Set} + \text{Nsc}$$

The night function with real-time clock is activated if nSC is not equal to 0 and the current time is greater than tdE and less than tdS (level 1 parameters).

2.20**PASSWORD FUNCTION**

The password function is activated by setting a value other than 0 for the PA parameter. See parameter P1 for different security levels.

Protection is automatically enabled after about 2 minutes of inactivity on the keyboard.

The figure 000 appears on the display. Use the up/down keys to change the number and the SET key to confirm it.

If you forget your password, use the universal number 100.

(PS. The normal display is restored if no keys are pressed after 2 minutes once you have entered the password screen).

2.21**EMERGENCY OPERATION IN THE EVENT
OF A FAULTY ROOM PROBE (E0)**

This safety mode ensures the operation of the compressor even in the event of a faulty environment probe (error E0).

With probe error E0 and CE1 other than 0, the compressor operates in work pause mode, with compressor ON for time CE1 and OFF for time CE2.

With CE1>0, in case of error E0, defrosts are managed as in the normal operating mode.

With CE1=0, the emergency operation remains disabled in the presence of error E0: the compressor remains off and defrosting is switched off to preserve the residual cold.

Eliminate the cause of error E0 as soon as possible and reactivate the normal function of the control for a correct temperature adjustment.

CHAPTER 3: OPTIONS

TELENET MONITORING/SUPERVISION SYSTEM

3.1

Perform the following steps to connect the 202 HYPERANGE to the TeleNET monitoring and supervision system:

1. Assign a unique network address using the level 2 variable Ad.
2. The card terminals to the TeleNET connection are **7=RS-485(A)** and **8=RS-485(B)**; observe (A) and (B) markings for the RS-485 line and do not make diagonal connections. Refer to the connection indicated in the figure below.
3. When creating the new instrument, set the "Module" as "**ECP200 2EV instrument**" on the TeleNET programme.

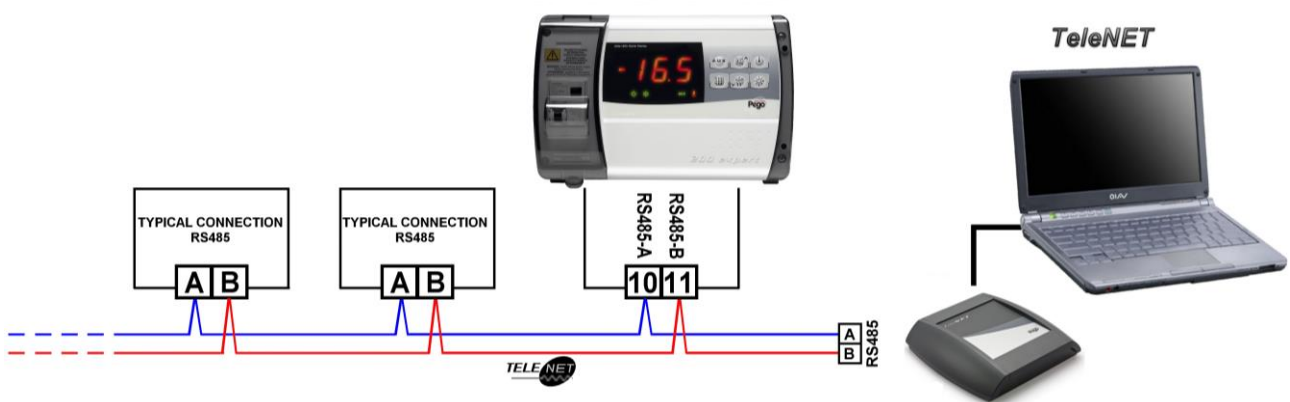

NETWORK CONFIGURATION WITH MODBUS-RTU PROTOCOL

3.2

To add the panel to an RS485 network with **Modbus-RTU** protocol, follow the diagram below.

Refer to the manual **MODBUS-RTU_ECP2022V** for the specifications of the MODBUS-RTU communication protocol.

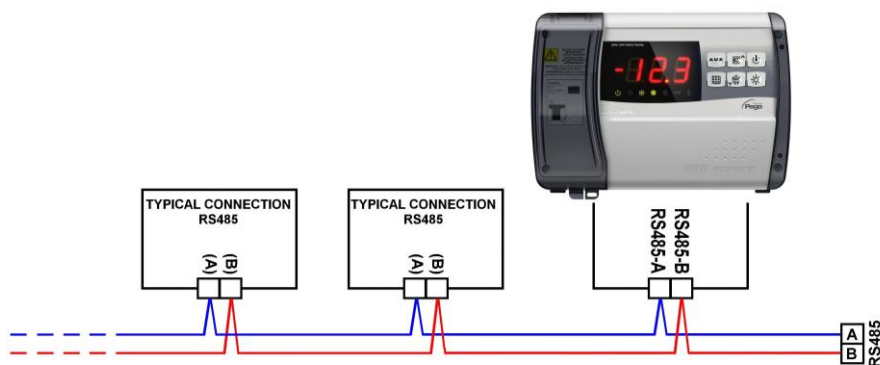

CHAPTER 4: DIAGNOSTICS

4.1

DIAGNOSTICS

In the event of a fault, the **202 HYPERANGE** controller alerts the operator through alarm codes displayed on the screen and an audio signal emitted by an internal buzzer. When an alarm condition occurs:

- the “alarm” icon is illuminated on the display,
- the alarm relay is activated (if configured)
- the internal buzzer is set off
- one of the following alarm codes appears on the display.

If you press the (**▲**) key at any time you can mute the internal buzzer and prevent the alarm code from being displayed. If the SET key is pressed again, the audio signal and code display are reset (serious alarms cannot be muted).

ALARM CODE	POSSIBLE CAUSE	OPERATION TO BE PERFORMED
E0	Ambient probe fault.	<ul style="list-style-type: none"> • Check the status of the ambient probe. • If the problem persists replace the probe.
Eu1	Defrost probe fault. In this case, any defrost will have a duration equal to time d31.	<ul style="list-style-type: none"> • Check the status of the defrost probe. • If the problem persists replace the probe.
Eu2	dE2 parameter configuration error.	<ul style="list-style-type: none"> • Set dE2 = 1
E2	Eeprom alarm. An EEPROM error has been detected (all the outputs are disabled except for the alarm)	<ul style="list-style-type: none"> • Switch the equipment off and on again
E3	AUE parameter configuration error.	<ul style="list-style-type: none"> • Set AUE = 0
EH	Maximum temperature alarm. A temperature above the temperature set for the maximum temperature alarm has been reached in the room (see variable A2, user programming level).	<ul style="list-style-type: none"> • Check the compressor status. • The probe does not detect the temperature correctly or the compressor stop/run command does not work.
EL	Minimum temperature alarm. A temperature below the temperature set for the minimum temperature alarm has been reached in the room (see variable A1, user programming level).	<ul style="list-style-type: none"> • Check the compressor status. • The probe does not detect the temperature correctly or the compressor stop/run command does not work.
Ed	Door open alarm. The door has stayed open longer than the set tdo time.	<ul style="list-style-type: none"> • Close the door. • Check the status of the door switch and its connections.
E8	Man in cold room alarm. The man in the cold room alarm button has been pressed to signal a hazard	<ul style="list-style-type: none"> • Reset the button inside the cold room.

Ec	Compressor protection triggered (e.g. thermal protection or pressure switch). The outputs are all deactivated except the alarm one, if present.	<ul style="list-style-type: none"> • Check the compressor status. • Check compressor absorption. • If the problem persists, contact technical support.
E9	Cold room light alarm. The cold room light has been switched on for a time exceeding tLo.	<ul style="list-style-type: none"> • Turn the light off with the LIGHT key.
E6	Low battery alarm. The check functions for at least another 20 days. If power to the panel is cut off, the time setting will be lost.	<ul style="list-style-type: none"> • Replace the CR2032 battery on the card.

ATTACHMENTS

200SCH202HYP CONNECTION DIAGRAM

A.1

200SCH202HYP

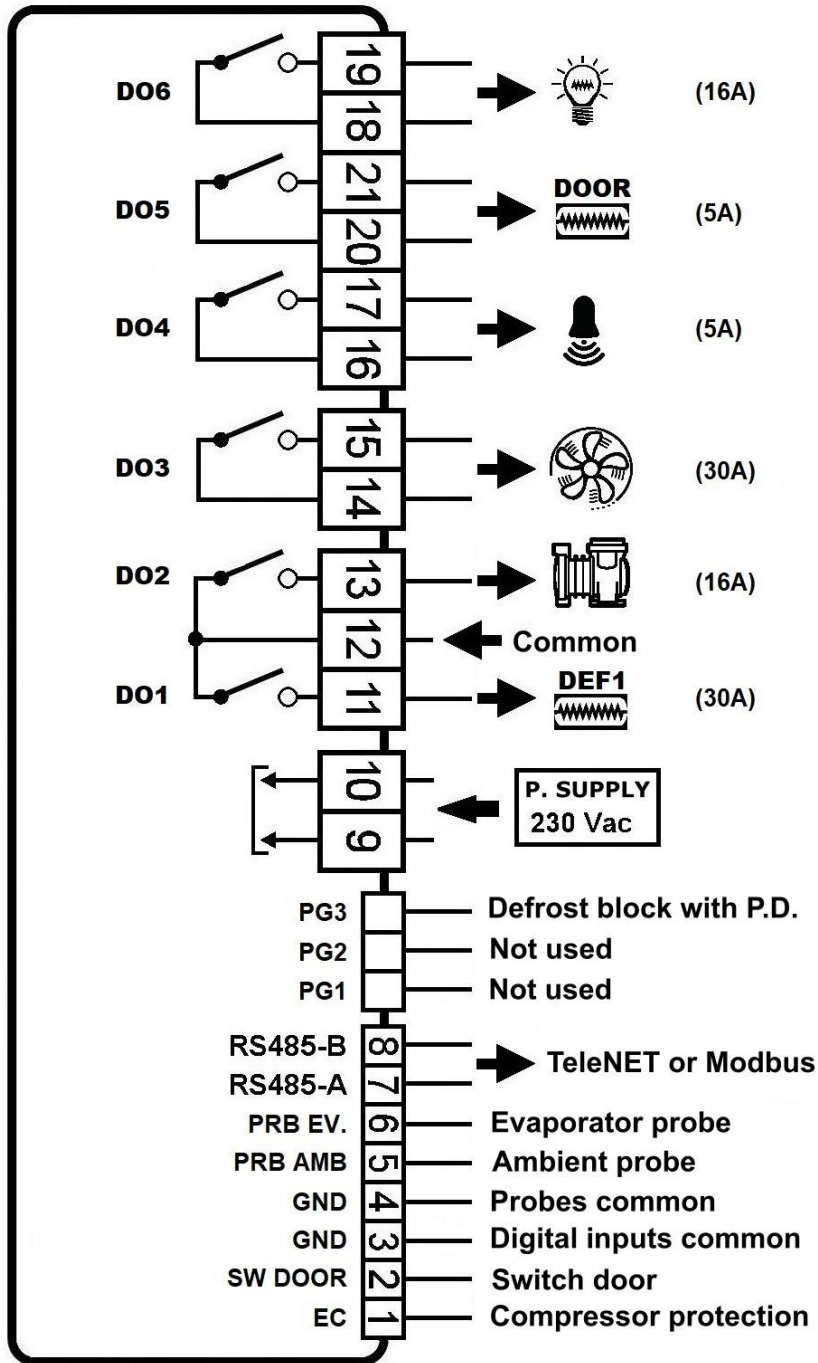



PEGO S.R.L.
Via Piacentina, 6/b 45030 Occhiobello (RO) - Italy
Tel. +39 0425 762906
e-mail: info@pego.it – www.pego.it

TECHNICAL SUPPORT
Tel. +39 0425 762906 e-mail: tecnico@pego.it

Distributor: