

# NEXUS S27

Driver for Stepper electronic expansion valve



---

User and maintenance manual

---

**ENGLISH**

**READ AND KEEP**

Rel. 1



# CONTENTS

## INTRODUCTION

Page 4	1.1	General
Page 4	1.2	Product identification codes
Page 5	1.3	Overall dimensions
Page 5	1.4	Identification data

**CHAP. 1**

## INSTALLATION

Page 6	2.1	General warnings for the installer
Page 6	2.2	Mechanical fixing

**CHAP. 2**

## TECHNICAL FEATURES

Page 7	3.1	Technical features
--------	-----	--------------------

**CHAP. 3**

## WARRANTY TERMS

Page 8	4.1	Warranty terms
--------	-----	----------------

**CHAP. 4**

## DATA PROGRAMMING

Page 9	5.1	Display description
Page 10	5.2	MyPego app interface
Page 13	5.2.1	Connections setup
Page 18	5.2.2	Instrument Sharing
Page 19	5.3	Web interface / http access
Page 23	5.4	Remote console interface (optional)
Page 23	5.4.1	Remote console icons (optional)
Page 24	5.4.2	Remote Console Key Combination (Optional)
Page 25	5.5	ESH set point setting and display
Page 26	5.6	Level 1 programming
Page 26	5.7	Level 1 parameter list
Page 28	5.8	Level 2 programming
Page 28	5.9	Level 2 parameter list
Page 32	5.9.1	Valve management (EEV parameter)
Page 32	5.10	Level 3 programming
Page 33	5.11	Level 3 parameter list
Page 35	5.12	Quick view menu (read-only)
Page 35	5.13	Quick view menu parameter list (read-only)
Page 35	5.14	Refrigerant temperature table
Page 36	5.15	Password function
Page 36	5.16	First start procedure
Page 36	5.17	Software update
Page 36	5.18	Parameters export/import

**CHAP. 5**

## OPTIONS

Page 37	6.1	TeleNET monitoring/supervision system
Page 37	6.2	Network configuration with Modbus-RTU protocol

**CHAP. 6**

## DIAGNOSTICS

Page 38	7.1	Diagnostics
---------	-----	-------------

**CHAP. 7**

## ANNEXES

Page 39	A.1	EU Declaration of Conformity
Page 40	A.2	Connection diagram
Page 41	A.3	Layout and description of sensors
Page 41	A.4	Valve compatibility and connection

# CHAPTER 1: INTRODUCTION

## GENERAL

### 1.1

#### DESCRIPTION:

The **NEXUSS27** is an electronic regulator for controlling the motorized electronic expansion valve, with integrated connectivity functions through the myPego app. It manages the most common motorized electronic expansion valves and integrates evaporator superheat management.

#### APPLICATIONS:

- Refrigerated counters and cold rooms.

#### MAIN FEATURES:

- Bluetooth, Wi-Fi and ethernet connectivity for installer interaction with the driver and diagnostics.
- Without console on board: the myPego APP is used for programming. An external console with IP65 protection can be connected as a service terminal.
- Motorized electronic expansion valve control (bipolar stepper).
- Easy valve parameter programming with 21 pre-configurations for the most common valves on the market. Possibility to manually define the valve parameters.
- Compatible with 23 types of gas: R404, R134, R22, R407A, R407F, R407H, R410A, R450A, R507, R513A, R744(CO2), R449A, R290, R32, R448A, R452A, R600, R600A, R1270, R1234ze, R23, R717(NH3), R454C.
- RS485 serial connection with TeleNET or Modbus protocol selectable by parameter.
- Three configurable digital inputs.
- Suction temperature and evaporation pressure probe for evaporator superheat management.
- Easy parameter programming with 4 pre-configurations for different applications of the electronic expansion valve.
- Alarm reporting.
- Auxiliary relay configurable as alarm / solenoid valve command.
- Password function.
- LED indications of the system status.
- Easy to use keyboard.
- USB input for Parameters export/import and software update.

## PRODUCT IDENTIFICATION CODES

### 1.2

#### NEXUSS27

Electronic regulator for controlling the motorized electronic expansion valve. Manages the most common stepper electronic expansion valves. Bluetooth, Wi-Fi and ethernet connectivity for installer interaction with the driver and diagnostics.  
Evaporator superheat management.

#### 200NANOTTL01

TTL remote console (**optional**).

## 1.3

## OVERALL DIMENSIONS

Dimensions in mm.

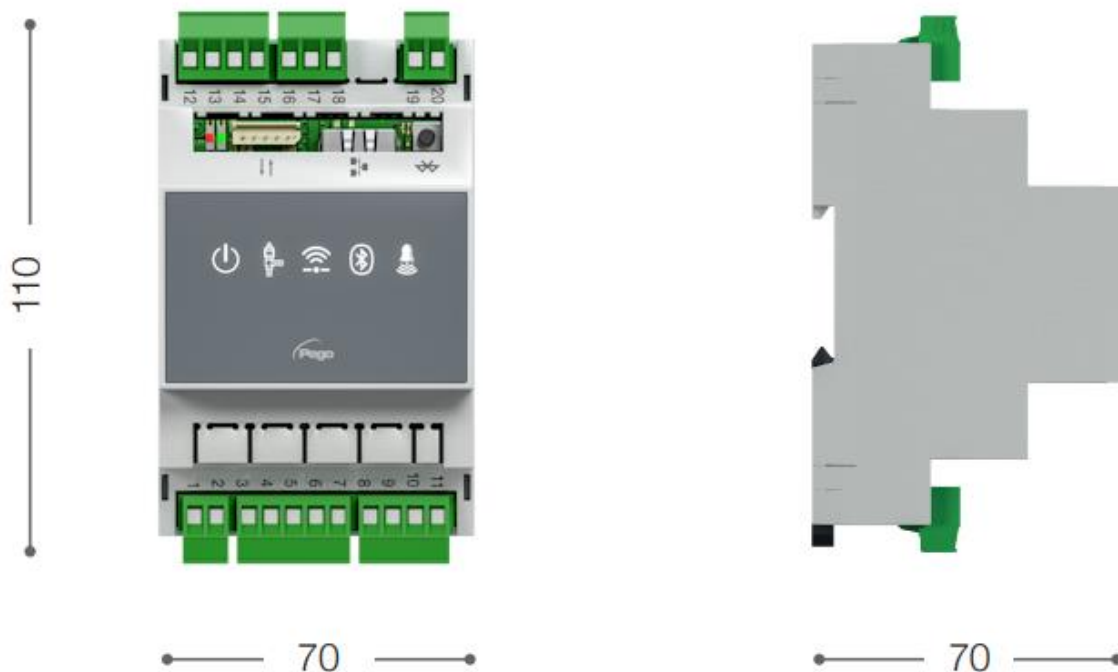

## 1.4

## IDENTIFICATION DATA

The device described in this manual has a plate on one side bearing the identification data:

- Name of Manufacturer
- Code and model of the device
- Serial number
- Date of manufacture
- Power supply

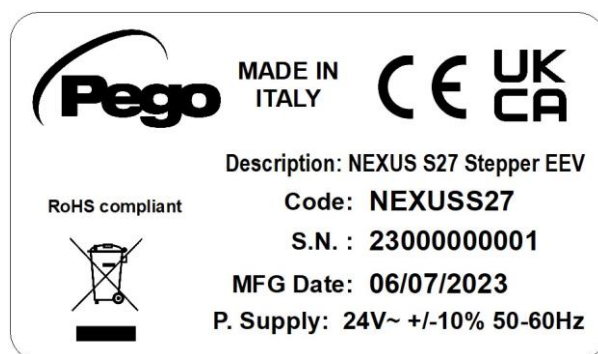

## CHAPTER 2: INSTALLATION

### GENERAL WARNINGS FOR THE INSTALLER

2.1

1. Install the appliance in places that respect the degree of protection and keep the box intact as much as possible when drilling the holes for housing the cable glands and/or pipe presses.
2. Avoid using multi-pole cables with conductors connected to inductive and power conductors and signal conductors like sensors and digital inputs.
3. Avoid putting in the same channels, power cables with signal cables (sensors and digital inputs).
4. Reduce the lengths of the connection cables as much as possible, preventing the wiring from taking the spiral shape harmful for possible inductive effects on electronics.
5. All electric cables used in wiring must be properly proportionate to support the load that must feed.
6. If it's necessary to prolong the probes cable, the use of appropriate section conductors, and in any case not less than 1mm<sup>2</sup>, is necessary. The extension or shortening of the probes could alter the factory calibration. Then proceed with the verification and calibration by means of an external thermometer.

### MECHANICAL FIXING

2.2

Place the Module on DIN guide and close the lower hook to block it on it.

Make all electric connections according to the attached patterns for the corresponding model (see the relative tables in attachments). During the wiring it is recommended to keep the power cables away from those of the signal.

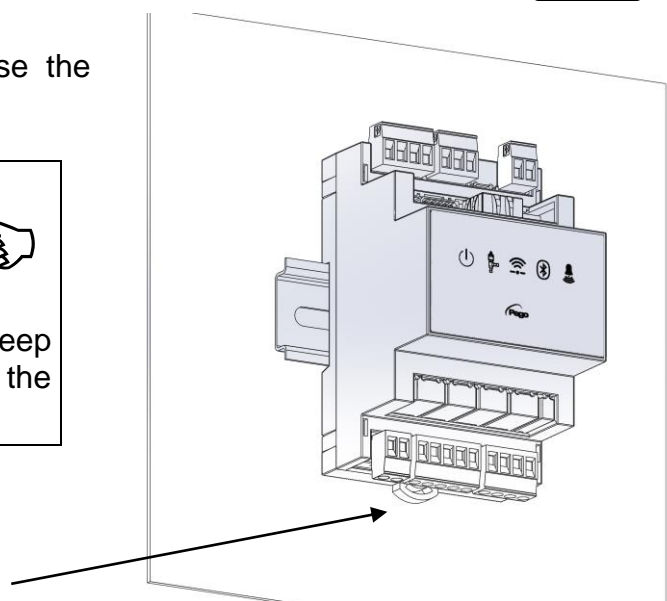

## CHAPTER 3: TECHNICAL FEATURES

### 3.1

### TECHNICAL FEATURES

Power supply		
Main Voltage	24 V~ ± 10% 50-60Hz	
Auxiliary power supply (dedicated for the backup battery)	24 V dc	
Max power consumption (electronic control only)	Depending on valve, maximum 25VA with ALCO EX8	
Climatic conditions		
Operating temperature	-5T50°C <90% R.H. non-condensing	
Storage temperature	-10T70°C <90% R.H. non-condensing	
General features		
Compatible types of temperature sensor	Temperature sensors: NTC 10K 1% / PT1000 / PTC	
Resolution of temperature sensors	0,1 °C	
Precision of temperature sensor detection	± 0,5 °C	
Range of temperature sensor detection	-45 ÷ +99 °C	
Compatible type of pressure sensor:	Pressure sensor: 4-20mA	
Output features		
Description		Features of output board
Alarm (voltage-free contact)	(8A AC1 Relay)	8(3)A 250V~
Stepper valve		Bipolar valve (4 wires): max 0,8 A <b><u>See valves compatibility table.</u></b>
Dimensional features		
Dimensions	12.15cm x 7.1cm x 10.5cm (HxPxL)	
Remote console dimensions (optional)	3.7cm x 2.31cm x 9.3cm (HxPxL)	
Insulation and mechanical properties		
Nexus degree of protection	IP20	
Degree of protection of the front of the remote console (front mounted)	IP65	
Material of boxes	UL94 V-0 self-extinguishing PC+ABS	
Type of insulation	II Class	

## WARRANTY TERMS

## 4.1

The **NEXUS** electronic controls are covered by a 24-months warranty against all manufacturing defects as from the date indicated on the product ID code.

In case of defect the product must be appropriately packaged and sent to our production plant or to any authorized Service Center with the prior request of the Return Authorization Number.

Customers are entitled to have defective products repaired, spare parts and labour included. The costs and the risks of transport are at the total charge of the Customer. Any warranty action does not extend or renew its expiration.

The Warranty does not cover:

- Damages resulting from tampering, impact or improper installation of the product and its accessories.
- Installation, use or maintenance that does not comply with the instructions provided with the product.
- Repair work carried out by unauthorized personnel.
- Damage due to natural phenomena such as lightning, natural disasters, etc.

In all these cases the costs for repair will be charged to the customer.

The intervention service in warranty can be refused when the equipment is modified or transformed.

Under no circumstances **Pego S.r.l.** will be liable for any loss of data and information, costs of goods or substitute services, damage to property, people or animals, loss of sales or earnings, business interruption, any direct, indirect, incidental, consequential, damaging, punitive, special or consequential damages, in any way whatsoever caused, whether they are contractual, extra contractual or due to negligence or other liability arising from the use of the product or its installation.

Malfunction caused by tampering, bumps, inadequate installation automatically declines the warranty. It is compulsory to observe all the instructions in this manual and the operating conditions of the product.

**Pego S.r.l.** disclaims any liability for possible inaccuracies contained in this manual if due to errors in printing or transcription.

**Pego S.r.l.** reserves the right to make changes to its products which it deems necessary or useful without affecting its essential characteristics.

Each new release of the PEGO product user manual replaces all the previous ones.

As far as not expressly indicated, is applicable the Law and in particular the art. 1512 C.C. (Italian Civil Code).



# CHAPTER 5: DATA PROGRAMMING

## 5.1

### DISPLAY DESCRIPTION



#### ENABLING ICON

Led OFF = Enable input OFF (see In1/2/3 configuration)  
Led ON = Enable input ON (see In1/2/3 configuration)



#### EEV OUTPUT STATUS ICON

Led OFF = Motorized valve closed  
Led ON = Motorized valve open



#### WEB CONNECTION ICON

Led OFF = Internet connection not active  
Led ON = Internet connection active (Wi-Fi or ethernet)



#### BLUETOOTH ICON

LED OFF = Bluetooth off  
Flashing LED = Bluetooth on, waiting for connection  
Led ON = Bluetooth on, smartphone connected



#### ALARM ICON

Led OFF = No alarm present  
Flashing LED = Alarm present

The **myPego** app is the official Pego application for the control and supervision of NEXUS line instruments. It is available for free on the App Store and Google Play Store.



My Pego® App

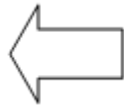

Direct connection to the device via Bluetooth BLE; monitoring system status; changing parameters and configuring Ethernet Wi-Fi connectivity.

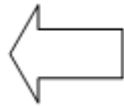

Cloud connection: monitoring of the status of all devices registered in the subscription plan; reading parameters and daily history; receiving real-time alarm notifications from all registered devices.

**Note:** full control with cCL=2.

**Direct connection via Bluetooth**

Choosing Bluetooth Connection, accesses the direct connection pages. Enable Bluetooth on the instrument by pressing the appropriate button (see attachment A.2) and confirm the connection in the app to access the instrument status page.

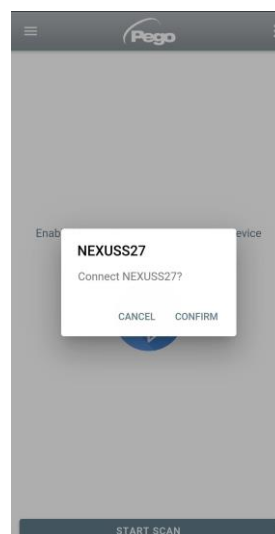
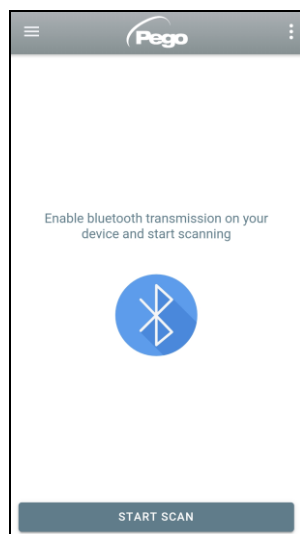

### Connecting to Cloud Device

Choosing the Cloud Connection accesses the tool selection page. Here it is possible to select which of the registered instruments (through the procedure indicated in the previous chapter) it is possible to access to monitor the status of the system.

The  icon indicates that the tool is successfully transmitting data to the cloud. Tap the name of a tool to access its status page.

**Note:** If the icon is grey, it may be necessary to set the date and time correctly on the instrument (parameters Hr, min, Yr, Mo, dy).

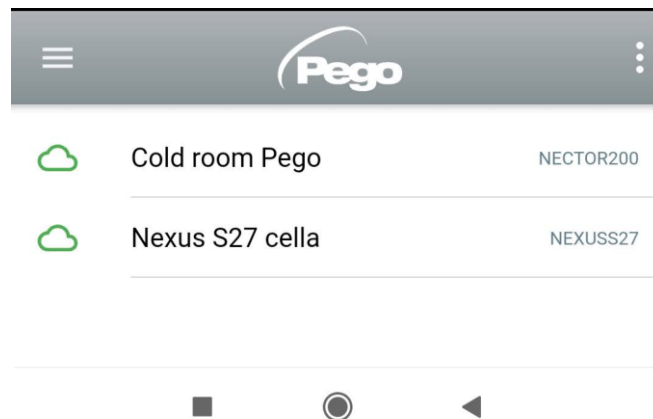

### NEXUS S27 instrument status

Once logged in (via Bluetooth if it's a nearby instrument or via the Cloud if it's a remote instrument) the NEXUSS27 status page opens.

Here it's possible to:

- Read the current superheat value.
- Read the setpoint and modify it (if connected via Bluetooth or if cCL=2).
- Check the status of inputs/outputs/alarms.
- Verify the main quantities relating to the expansion in the evaporator, in real time:
  - tS4: suction probe temperature
  - tS5: evaporation temperature (converted)
  - PS5: evaporation pressure
  - oEV: electronic valve opening %
  - PAS: number of electronic valve opening steps

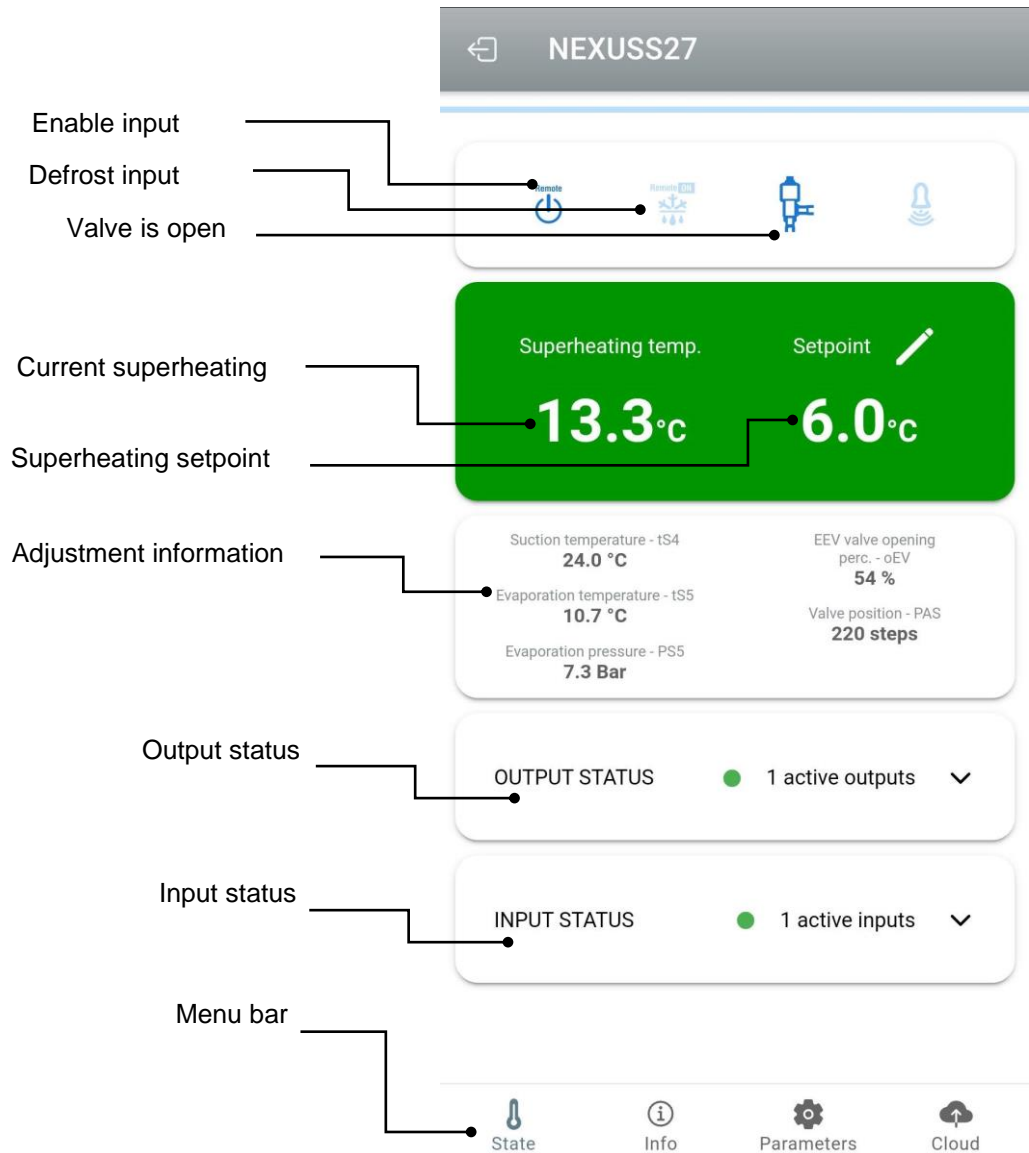

By touching the keys on the bottom bar it's possible to access the other configuration pages:

**- Info page**

It contains the basic information of the instrument and the name by which the instrument is identified on the Cloud.

*Instrument name on cloud, editable if connected via Bluetooth.*

*Manual: link to download the user manual in pdf.*

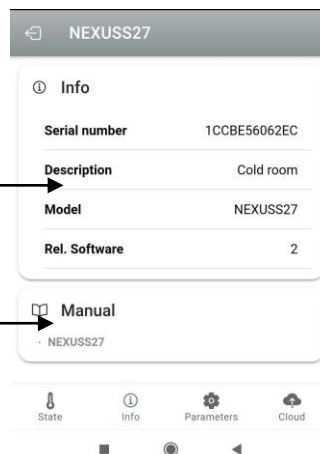

**Parameters page**

**Cloud page**

Allows the configuration of the connection to the cloud and the network settings (see the Chapter Connections setup).

**5.2.1**

**CONNECTIONS SETUP**

The NEXUS controller is equipped with Bluetooth BLE, Wi-Fi or ethernet connectivity for management or monitoring via remote devices (tablet, smartphone, PC).

In particular, the remote management of the device takes place in the following ways:

	Distance	Support	Channel	Mode
<b>MyPego app (BLE)</b>	approx. 50m	Smartphone, Tablet	Bluetooth BLE	Control and monitoring
<b>MyPego app (Cloud)</b>	---	Smartphone, Tablet	Wi-Fi, Ethernet	Real-time monitoring and notifications. Control, if cCL=2.
<b>Integrated webserver</b>	---	Smartphone, Tablet, PC	Wi-Fi, Ethernet	Control (with cSL=2) and monitoring. Network configuration required.

**The myPego app is available on Google and Apple stores for free.**

It allows complete control of the NEXUS instrument and is necessary to carry out the basic operations to connect the device to the Internet (IP address check, Wi-Fi username and password entry, etc.). Through the same application it is possible to receive notifications from NEXUS instruments in the event of an alarm and monitor the status of the registered devices (subscription function, see the dedicated chapter).

To connect the NEXUS instrument to the internet via Wi-Fi or ethernet, do the following:

- 1) Download the **myPego** app from the Google/Apple store and install it on a smartphone/tablet.
- 2) Activate Bluetooth on the NEXUS instrument with the dedicated activation key. The flashing  icon activates.

- 3) Open the myPego app and access the Bluetooth section.



- 4) Touch the "Scan" key and the "Confirm" key to make the connection. The Bluetooth icon  on the instrument turns on steady to signal the connection.

- 5) The homepage of the application opens, where it is possible to see the superheat and consult the status of the inputs and outputs.

- 6) In the selection bar below, tap the "Cloud" icon to access the network configuration menu.



- 7) Upon first sign in, the myPego app prompts setting up of your Cloud connection. If relevant, continue by pressing the "Ok" key otherwise press "Cancel" and skip directly to step 14).

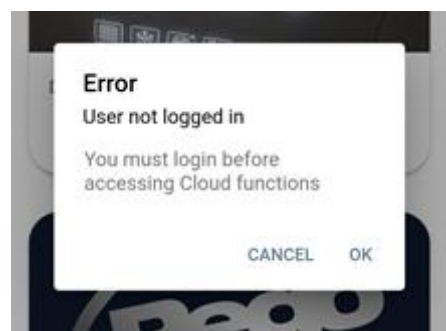

8) By clicking “Ok” in the previous point, the Login page opens. If already registered, enter the registration e-mail and password and click Login. Otherwise click "Sign in" to make the first registration.

9) If you are registering for the first time, please enter a valid e-mail address and password.

A verification email will be sent to the address indicated: click on the link in the email to confirm the registration.

Once registration is confirmed, you will be able to log in with the account created (see point 8).



10) Once the user has been created (or logged in with an existing user), the device must be associated with an existing Cloud subscription; or create a new subscription. Touch the second link to associate the device with the registered user's cloud subscription.

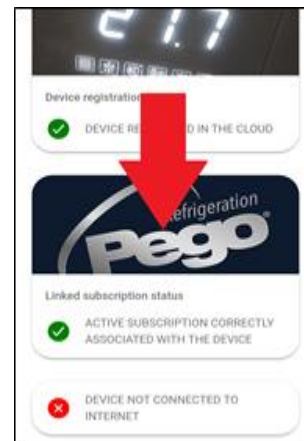

11) If the user does not have an active cloud subscription, the subscription activation page opens.

Select the type of plan you need based on the number of instruments you want to monitor.

Continue with the activation of the plan through the payment page.

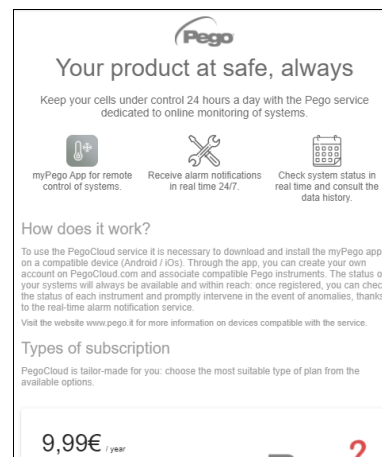

- 12) Enter your payment details (only the methods provided in the app are available).

The charge will take place only after the trial period and it is possible to interrupt the renewal of the subscription at any time.

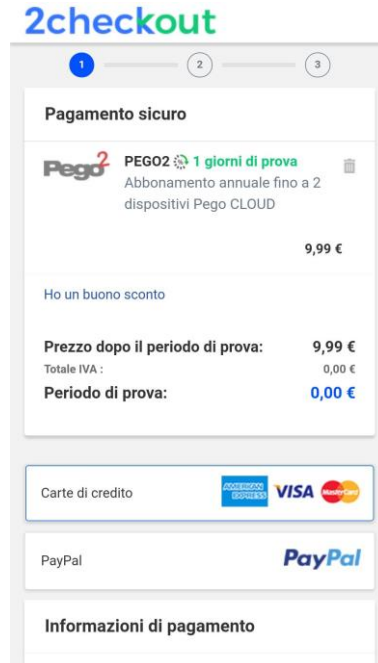

- 13) Once the subscription plan has been created, it is possible to associate the instrument with the Cloud.

Then return to the "Cloud" page of the app (Bluetooth side) and associate the device by clicking on the second tab. Turn the NEXUS off and on again.

The device is thus associated with the subscription, but to allow data transmission it is necessary to configure the Wi-Fi / Ethernet connection to the internet.



- 14) Touch the last link at the bottom "DEVICE NOT CONNECTED TO THE INTERNET" to configure the connection.

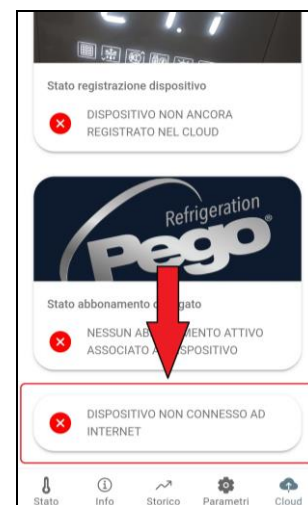



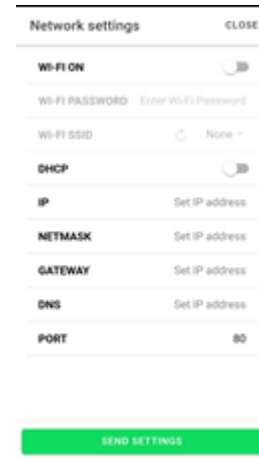

15) Configure the type of connection:

- **If ethernet connection:**  
connect the cable to the NEXUS instrument and set the DHCP or set the desired IP / NETMASK / GATEWAY configuration. At the end, touch the "Send settings" key to configure the instrument. If DHCP is activated, it will be necessary to return to this page after a few moments, to check the IP received from the DHCP server.
- **If Wi-Fi connection:**  
touch the WI-FI ON switch and configure the SSID and password of the network to which the NEXUS will connect. Enable DHCP if needed.



**At the end of the setting, touch the "Send settings" key.**

16) At the end of the configuration, when the instrument is connected (via Wi-Fi or ethernet) the  icon is activated (after about one minute). You may need to power cycle your NEXUS

17) If the Cloud connection was configured (see point 13), after a few moments the  icon is activated to signal that the device is correctly sending data to the Pego Cloud.

INSTRUMENT SHARING

5.2.2

The "Instrument Sharing" function allows you to share the NEXUS with other users (up to 3) even if they are not subscribers (it's sufficient that each user has their own account).

Sharing users:

- receive alarms and notifications.
- can check the status of the NEXUS device.
- can send commands and modify parameters (if cCL=2).

To share, the instrument must be correctly registered in the Cloud.

**Note:** It's not possible to log in with the same user from multiple different devices at the same time.

- 1) Open the tool in the Cloud section of the myPego app, go to the Cloud page and select the last link ("Share the device in the Cloud").

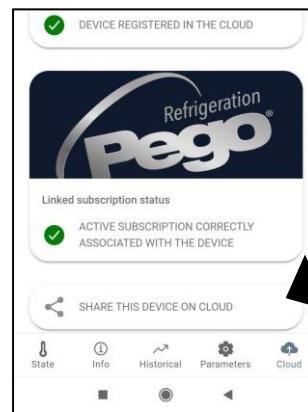

- 2) Touch the (+) symbol to add a shared user; in the window that appears enter the email address of the user with whom you want to share the NEXUS. Touch the "Share" button to share.

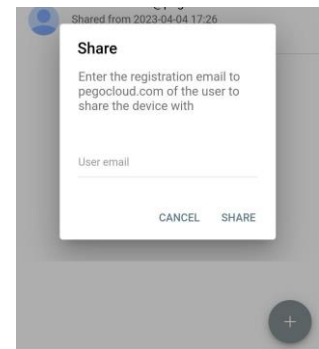
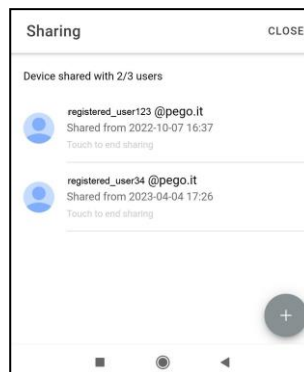

- 3) If sharing is successful, the shared user is added to the list. You can share your NEXUS with up to three users.

**Note:** the owner can stop sharing at any time by touching the icon next to the shared user.

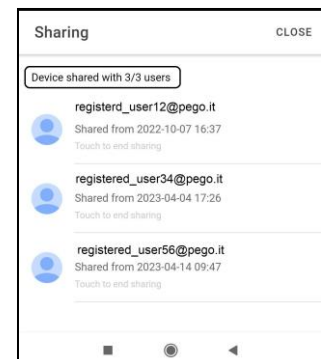
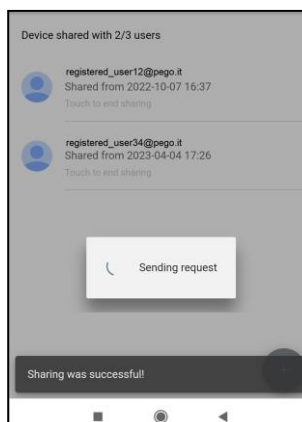

5.3

WEB INTERFACE / HTTP ACCESS

The NEXUS instrument integrates a web server which allows the monitoring and modification of the parameters through a normal web browser or direct http interface. To access the instrument's website, you need to know its IP address using the procedure described in the "Connections setup" chapter (via the myPego app => Bluetooth connection => cloud card).

**HTTP ACCESS**

By sending properly formatted requests with the http protocol to the IP address of the device, it is possible to access information in real time, change parameters, send commands, etc. Access to this feature is password protected. Below is an example of communication between a third-party system (which sends the request) and the NEXUS (which sends the response).

Request:

http://IP1.IP2.IP3.IP4/ajax\_data.cgi?pgd='passcode'

Answer:

```
{"temp":23.8,"sttmp":-0.5,"bg_temp":1,"stby":0,"ligh":0,"def":0,"almst":0,"recst":0}
```

temp =	current room temperature	sttmp =	temperature setpoint
bg_temp =	reserved	stby =	stand-by status
ligh =	cold room light status	def =	defrost status
almst =	alarm present	recst =	active registrations

For further information, refer to the dedicated manual to be requested from Pego.

**WEB SERVER**

Type the local IP address of the connected instrument in the address bar of the web browser: the access page appears. Access to the NEXUS homepage is subject to access control using a username and password.

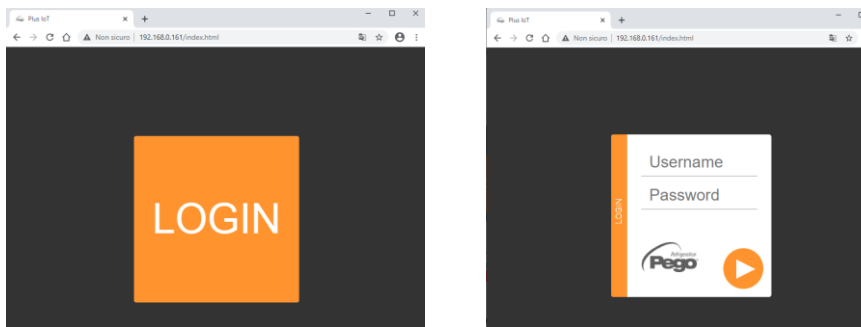

The NEXUS web pages can be accessed in two ways, based on the value of the cSL parameter (1st level parameters):

- If **cSL=1**, normal user: by entering the string "admin" in the "Username" field and the value set in the "PA" parameter in the "Password" field (1st level, e.g. if PA=6 enter the password: "006") is accessed in read-only mode. The modification of the parameters, the setpoint and the manual activation of the outputs (e.g. light, defrost, etc.) are therefore inhibited.
- If **cSL=2**, Administrator user: inserting the string "admin" in the "Username" field and the value set in the "PA" parameter in the "Password" field (3rd level, e.g. if PA=6 insert password: "006") you have full access to the functions. It is therefore possible to modify the parameters and access all the functions.

The web interface consists of a few fixed sections:

- left: page navigation menu.
- above: page name, serial number and type of connected user.
- right: page content.

### - Main page

The screenshot shows the main page of the NEXUS S27 web interface. The interface is divided into several sections:

- Page navigation menu:** Located on the left side, it includes links for Live, I/O, Command, Setup, Info, and Logout.
- Current page:** The word "Live" is displayed below the navigation menu.
- Current superheat (and temperature setpoint):** A large blue box displays the current temperature as 13.3 °C and the setpoint as 6.0 °C.
- Access type (admin or user):** The text "s/n: 1CCBE56062EC- admin" is displayed in the top right corner.
- Alarms:** A section below the temperature display shows three icons: a green power button, a green key, and a grey snowflake. A callout explains that red indicates an alarm in progress and grey indicates no alarm.
- Logout:** A callout explains that the Logout button logs out the user and returns to the login page.

Copyright © Pego S.r.l.

- I/O (Inputs / Outputs)

The screenshot shows the 'I/O' configuration page in the NEXUS interface. It features a sidebar with navigation options: Live, I/O, Command, Setup, Info, and Logout. The main content area is titled 'I/O' and includes a table for 'Analogue inputs' and a section for 'Digital outputs'. The 'Analogue inputs' table lists 9 inputs with their descriptions and values. The 'Digital outputs' section shows 'OUT 1' with an 'Alarm' status. Three callout boxes provide explanations for the data columns: 'Input/output terminal PIN', 'Input / output description (digital or analog)', and 'Input/output status'.

Analogue inputs		
IN 1	Suction Temperature Probe (S4)	24.0 °C
IN 2	Evaporation Temperature Probe (S5)	10.8 °C
IN 3	Evaporation Pressure Probe (S5)	7.4 Bar
IN 4	Overheating temperature (tSH)	13.2 °C
IN 5	% EEV valve opening	100
IN 6	Number of steps	410
IN 7	Door switch	●
IN 8	Disabled	●
IN 9	Disabled	●

Digital outputs	
OUT 1	Alarm

**Input/output terminal PIN**

**Input / output description (digital or analog)**

**Input/output status**  
 If digital:  
 - green: input / output active  
 - grey: input / output not active  
 If analog, the analog input or output value is displayed.

- Commands => Parameters

The screenshot shows the 'Parameters' menu in the NEXUS interface. The sidebar is the same as in the previous screenshot. The main content area is titled 'Parameters' and lists several menu items: Setpoint, Level 1, Level 2, Level 3, and Probes Level. A callout box points to the dropdown arrows next to 'Level 3', explaining that clicking on the arrow will view the parameter list.

**Parameters menu**  
 Click on the arrow to view the parameter list.

Parameter code	Parameter description	Current value	Increases or decreases value
In1	Digital input 1 configuration	1	+ -
In2	Digital input 2 configuration	0	+ -
In3	Digital input 3 configuration	0	+ -

- Setup

On the "Setup" page it's possible to configure the language of the webserver.



- Info



5.4

REMOTE CONSOLE INTERFACE (OPTIONAL)

200NANOTTTL01



1



**UP KEY**

Increase values / Scroll up parameters  
Silence the audible alarm if present / Acquire an alarm.

2



**DOWN KEY**

Decrease values / Scroll down parameters

3

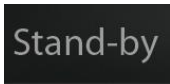

**STAND BY KEY**

The NEXUS-S27 instrument **cannot** be paused with this key but only by removing the enabling from the digital input or from LAN.

4



**SET KEY**

View the set point.  
Allows you to set the SUPERHEATING setpoint if pressed in combination with the Down key or the UP key.  
Resets the audible alarm, if present.

5.4.1

REMOTE CONSOLE ICONS (OPTIONAL)

5



**DISPLAY**

View the values / parameters

6



**DEFROST CALL ICON**

Led OFF = Defrost input OFF  
Led ON = Defrost input ON

7



**EEV OUTPUT STATUS ICON** Electronic valve output status

Led OFF = Motorized valve closed  
Led ON = Motorized valve open

8



**“PRG” ICON**

Flashing LED = In programming

9

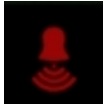
**"ALARM PRESENT" ICON**

Led OFF = No alarm present.  
 Led ON = Alarm triggered and then reset.  
 Flashing LED = Alarm present.

**REMOTE CONSOLE KEY COMBINATION (OPTIONAL)****5.4.2****EXIT PROGRAMMING**

If pressed simultaneously for more than 3 seconds inside any programming menu, they save the settings made by exiting the menu itself.

When the menu is exited, a confirmation BEEP is generated.

**1st LEVEL PROGRAMMING**

If pressed simultaneously for more than 3 seconds, they allow access to the 1st level programming menu.

When entering the menu, a confirmation BEEP is generated.

This menu is exited automatically after 30 seconds of keyboard inactivity or by pressing the up arrow + down arrow (exit confirmation beep).

**2nd LEVEL PROGRAMMING (EEV parameters)**

If pressed simultaneously for more than 3 seconds, they allow access to the 2nd level programming menu.

When entering the menu, a confirmation BEEP is generated.

This menu is exited automatically after 30 seconds of keyboard inactivity or by pressing the up arrow + down arrow (exit confirmation beep).

**3rd LEVEL PROGRAMMING (Stepper valve parameters)**

If pressed simultaneously for more than 3 seconds, they allow access to the 3rd level programming menu. When entering the menu, a confirmation BEEP is generated. By entering this menu, the regulation is interrupted and the valve is closed.

This menu can be exited by pressing the up arrow + down arrow (exit confirmation beep).

**USB MANAGEMENT LEVEL (Parameter export / import)**

If pressed simultaneously for more than 3 seconds, they allow access to the USB management menu for Parameters export/import and software update. When entering the menu, a confirmation BEEP is generated. This menu can be exited by selecting the "nO" item (exit confirmation beep).





### QUICK VIEW MENU (READ ONLY)

If pressed simultaneously for more than 3 seconds, they allow access to the quick display menu.

When entering the menu, a confirmation BEEP is generated.

Within this menu, the up and down arrows allow you to scroll through the various parameters.

Pressing the Set key alternates the display of the parameter with its value.

With the parameter value displayed, pressing the up or down arrows still leads to the display of the next or previous parameter to the current one.

This menu is exited automatically after 2 minutes of keyboard inactivity or by pressing the up arrow + down arrow (exit confirmation beep).

## 5.5

### ESH SET POINT SETTING AND DISPLAY

#### Via the myPego app:

1. Open the myPego app and connect to the instrument called "NEXUSS27" via Bluetooth or via cloud.
2. The superheat setpoint is immediately visible on the homepage, on the right. To change the value, touch the pencil next to the value. ESH SETPOINT range: 0.1 – 25°C.

#### With remote console:

1. Press the SET key to display the current SETPOINT value (ESH).
2. By keeping the SET key pressed and pressing one of the keys (▲) or (▼) the value of SETPOINT ESH is changed.

Release the SET key to return to displaying the ESH temperature, the modifications made will be stored automatically. ESH SETPOINT range: 0.1 – 25°C.

## 1st LEVEL PROGRAMMING (Installer level)

5.6

**Via the myPego app:**

1. Open the myPego app and connect to the instrument called "NEXUSS27" via Bluetooth or via cloud.
2. Touch the "Parameters" button in the bottom toolbar.
3. Consult / modify the parameters of the desired level.

**With remote console:**

To access the first programming level, press and hold down the UP (▲), DOWN (▼) and STAND-BY keys for more than 3 seconds. When the first programming parameter appears:

1. Select with the (▲) key or the (▼) key the parameter to be modified. After selecting the desired parameter, you will be able to:
  - Display the setting by pressing the **SET** key.
  - Change the setting by holding down the **SET** key and pressing one of the (▲) or (▼) keys.
2. Once the configuration values have been set, to leave the menu, press and hold the (▲) and (▼) keys for a few seconds until the cold room temperature value reappears. The menu can also be exited after 30 seconds of inactivity on the keyboard.
3. Changes made to the parameters will be automatically saved when leaving the configuration menu.

**The regulation of the valve continues even when you are inside the menu.**

## LIST OF 1ST LEVEL PARAMETERS (Installer level)

5.7

PAR.	MEANING	VALUES	DEFAULT
In1	Digital input DI1 setting and activation status.	4 = emergency closing (N.O.) 3 = tPF % fixed opening (N.O.) 2 = Defrost (N.O.) 1 = ON Driver EEV (N.O.) 0 = Disabled -1 = ON Driver EEV (N.C.) -2 = Defrost (N.C.) -3 = tPF % fixed opening (N.C.) -4 = emergency closing (N.C.)	1
In2	Digital input DI2 setting and activation status.	- Same legend as In1 values -	0
In3	Digital input DI3 setting and activation status.	- Same legend as In1 values -	0
DO1	DO1 digital output function setting. Note: By solenoid valve command we mean the normal solenoid valve command, therefore this output becomes the repetition of the ON input of the Driver.	2 = DO1 relay active for solenoid valve command. 1 = DO1 relay active in the presence of an alarm. 0 = DO1 relay disabled. -1 = DO1 relay deactivated in the presence of an alarm. -2 = DO1 relay deactivated for solenoid valve command.	1

PAR.	MEANING	VALUES	DEFAULT
diS	Visualization on the main display	1 = (tS4) Probe visualization (S4) Suction temperature. 2 = (tS5) Probe display (S5) Evaporation temperature. 3 = (PS5) Probe display (S5) Evaporation pressure. 4 = (tSH) Superheating temperature display. 5 = (oEV) valve opening percentage.	4
SEr	Communication protocol on RS-485	0 = TeleNET Protocol 1 = Modbus-RTU Protocol	0
Ad	Network address for connection to the TeleNET / Modbus-RTU supervision system.	0 ÷ 31 if SEr=0 1 ÷ 247 if SEr=1	1
Bdr	Modbus baudrate	0 = 300 baud      3 = 2400 baud      6 = 14400 baud 1 = 600 baud      4 = 4800 baud      7 = 19200 baud 2 = 1200 baud     5 = 9600 baud      8 = 38400 baud	5
Prt	Modbus parity check	0 = none 1 = even 2 = odd	0
bEE	Buzzer enabling	0 = disabled 1 = enabled	1
P1	Password: protection type. Active when PA is other than 0	0 = displays only the set point and allows alarm silencing. Blocks all other functions. 1 = displays the set point, allows the alarms to be silenced, + accesses the quick view menu. 2 = blocks 1st, 2nd and 3rd level programming access (all other functions are allowed). 3 = block access to 2nd and 3rd level programming (all other functions are allowed). 4 = blocks access to 3rd level programming (all other functions are allowed).	4
PA	Password. (see P1 for type of protection).	0...999 0 = Function disabled	0
dy	Day setting	1 ÷ 31	1
Mo	Month setting	1 ÷ 12	1
Yr	Year setting	0 ÷ 99	20
Hr	Time setting	Hour	12
Min	Minute setting	Minutes	0
cE	Network connection type	0 = Ethernet 1 = Wi-Fi	0
cB	Bluetooth Management	0 = Bluetooth disabled 1 = Bluetooth activatable	1
cCL	Cloud management	0 = disabled 1 = active, read only 2 = active, read/write parameters and commands	1
cSL	Local web server management	0 = disabled 1 = active (data display only) 2 = active (data display and command reception)	2

PAR.	MEANING	VALUES	DEFAULT
dEF	Setting the default parameters	<p><b><u>Via the myPego app:</u></b> Send the value "291" to restore the default parameters.</p> <p><b><u>With remote console:</u></b> Position on the dEF parameter and press all the keys for 10 seconds to restore the default parameters.</p>	---
reL	Release software	read only	read only

**2nd LEVEL PROGRAMMING (EEV Parameters)**

**5.8**

**Via the myPego app:**

1. Open the myPego app and connect to the instrument called "NEXUSS27" via Bluetooth or via cloud.
2. Touch the "Parameters" button in the bottom toolbar.
3. Consult / modify the parameters of the desired level.

**With remote console:**

To access the second programming level, press and hold down the UP (▲) and STAND-BY keys for more than 3 seconds.

When the first programming parameter appears:

1. Select with the (▲) key or the (▼) key the parameter to be modified. After selecting it you will be able to:
  - Display the setting by pressing the **SET** key.
  - Change the setting by holding down the **SET** key and pressing one of the (▲) or (▼) keys.
2. Once the configuration values have been set, to leave the menu, press and hold the (▲) and (▼) keys for a few seconds until the cold room temperature value reappears. The menu can also be exited after 30 seconds of inactivity on the keyboard.
3. Changes made to the parameters will be automatically saved when leaving the configuration menu.

**The regulation of the valve continues even when you are inside the menu.**

**2nd LEVEL PARAMETERS LIST (EEV Parameters)**

**5.9**

PAR.	MEANING	VALUES	DEFAULT
EEV	<p><b>EEV electronic valve management</b> Settings 1 to 5 load default values in parameters <b>ECt, EPb, Etl, Etd, ELS.</b></p> <p>For more details, see the table "Loading default settings based on the EEV parameter" at the end of chapter 5.9.</p>	<p>1 = EEV control (default 1) 2 = EEV control (default 2) 3 = EEV control (default 3) 4 = EEV control (default 4) 5 = EEV control (default 5) 6 = EEV control via Modbus (register 1536) 7 = EEV control via 0-10V input</p> <p>(see table on Page 31)</p>	1

PAR.	MEANING	VALUES	DEFAULT
ErE	<b>Type of refrigerant GAS used.</b> Setting this parameter is of fundamental importance for correct operation.	0 = R404 1 = R134 2 = R22 3 = R407A 4 = R407F 5 = R407H 6 = R410A 7 = R450A 8 = R507 9 = R513A 10=R744(CO2) 11 = R449A 12 = R290 13 = R32 14 = R448A 15 = R452A 16 = R600 17 = R600A 18 = R1270 19 = R1234ze 20 = R23 21 = R717(NH3) 22 = R454C	0
EPb	<b>Proportional band</b> (gain) PID superheat regulation.	1 ÷ 100%	15%
Etl	<b>Integral time</b> of PID algorithm for superheat regulation.	0 ÷ 500 sec steps of 2 seconds	100 sec
Etd	<b>Derivative time</b> PID algorithm superheat control.	0 ÷ 10,0 sec steps of 0.1 seconds	2,0 sec
EOE	<b>EEV valve opening percentage in case of probe S4 or S5 error.</b> This function allows you to continue the regulation albeit in a non-optimal way in the event of a fault in the regulation probes.	0 ÷ 100%	50%
ESO	During the Start phase, the EEV valve opens at the ESO percentage for the ESt time.	0 ÷ 100%	85%
ESt	<b>Duration of the Start phase.</b> In this phase the MOP, LOP, LSH alarms are disabled.	0 ÷ Edt tens of seconds	6 tens of seconds
EdO	<b>After the defrost, the EEV valve opens at the EdO percentage for the Edt time.</b>	0 ÷ 100%	100%
Edt	<b>Duration of the EdO valve opening phase after the defrost.</b> In this phase the MOP, LOP, LSH alarms are disabled.	ESt ÷ 250 tens of seconds	24 tens of seconds
EHO	<b>Maximum percentage of opening of the EEV valve.</b> In the case of an oversized valve, this parameter allows you to limit its maximum opening to the set percentage.	0 ÷ 100%	100%
EPt	<b>Type of temperature transducer (S4):</b> it sets the type of transducer used to detect the temperature (S4)	0 = NTC 1 = PT1000 2 = PTC (-45/80 °C)	0
EP4	<b>Pressure (bar) corresponding to 4mA or 0V.</b> Referred to the Evaporation pressure probe (S5).	-1.0 ÷ EP2 bar	0.0 bar
EP2	<b>Pressure (bar) corresponding to 20mA or 5V.</b> Referred to the Evaporation pressure probe (S5).	EP4 ÷ 90.0 bar	12.0 bar
CA4	<b>Inlet temperature transducer calibration (S4)</b>	-10,0 ÷ +10,0 °C	0,0 °C
CA5	<b>Evaporation pressure transducer calibration (S5)</b>	-10,0 ÷ +10,0 bar	0,0 bar
LSH	<b>LSH threshold (Low superheat temperature)</b> Too low superheat values can cause liquid backflow to the compressor or strong oscillations. Below the LSH value, the ELS protection intervenes which increases the speed of the PID when closing the valve to reach the set superheat.	0,0 ÷ Set SH °C	2,0 °C

PAR.	MEANING	VALUES	DEFAULT
<b>ELS</b>	<p><b>Low superheating protection.</b>                      If enabled, when SH &lt; LSH the PID integration time is set according to the selection from 1 to 7 of ELS. Setting 1 is the one that generates a faster closure. When this protection is activated, the SHd count starts for the activation of the LSH alarm.</p> <p><b>LSH SECURITY TAKES PRIORITY OVER LOP SECURITY.</b></p> <p>THE LSH PROTECTION IS NOT ACTIVATED DURING THE START PHASE (EST TIME), DURING THE DEFROST OR POST-DEFROST PHASE (Edt TIME).</p>	<p>0 = LSH protection and relative LSH alarm signaling disabled.                      1 = 5% Etl                      2 = 10% Etl                      3 = 15% Etl                      4 = 20% Etl                      5 = 25% Etl                      6 = 30% Etl                      7 = 35% Etl                      8 = 50% Etl                      9 = 100% Etl (no correction and only activates the LSH alarm).</p>	2
<b>SHd</b>	<p><b>Superheating alarm activation delay:</b> the LSH superheat alarm is signaled only after it has remained active for the SHd time. In the event of an LSH alarm, the valve closes in any case instantaneous;                      The alarm is self-resetting and stops when SH ≥ LSH.                      With active alarm we have:                      - Written LSH flashing on the display.                      - Buzzers.</p>	0 ÷ 240 tens of seconds	30
<b>MOP</b>	<p><b>MOP threshold (Maximum saturated evaporation temperature referred to sensor S5).</b>                      It represents the maximum evaporation pressure, expressed in saturated degrees, above which the MOP protection is activated (Parameter EMO). In the event of MOP, the controller closes the valve to limit the evaporation temperature and prevent the compressor from stopping due to thermal protection.</p>	(LOP+1) ÷ +45°C	+45°C
<b>EMO</b>	<p><b>MOP protection (active with tS5&gt;MOP).</b>                      When the evaporation temperature (tS5) is higher than the MOP threshold, the controller interrupts superheat regulation and the valve closes, trying to limit the evaporation temperature (and therefore the pressure). The valve closing speed depends not only on the difference between the evaporation temperature and the MOP threshold, but also on the EMO integral time parameter: the lower it is, the shorter the valve closing time will be. When this protection is activated, the Mod count starts for the activation of the MOP alarm. THE MOP PROTECTION IS NOT ACTIVATED DURING THE START PHASE (TIME Est), DURING THE DEFROST OR POST-DEFROST PHASE (TIME Edt).</p>	<p>0 = MOP protection and relative MOP alarm signal disabled</p> <p>0 ÷ 500 seconds steps of 2 seconds</p>	0
<b>Mod</b>	<p><b>MOP alarm activation delay:</b> the MOP alarm is signaled only after the MOP protection has remained active for the time Mod. The alarm is self-resetting when "Temp.S5" ≤ MOP                      With active alarm we have:                      - Written MOP flashing on the display.                      - Buzzers.</p>	0 ÷ 240 tens of seconds	60

PAR.	MEANING	VALUES	DEFAULT
LOP	<b>LOP threshold (minimum saturated evaporation temperature referred to sensor S5).</b> It represents the minimum evaporation pressure, expressed in saturated degrees, below which the LOP protection is activated. In the event of LPO, the control opens the valve to prevent the compressor from stopping due to low pressure (mechanical pressure switch).	-45°C ÷ (MOP-1)	-45°C
ELO	<b>LOP protection (active with tS5 &lt; LOP).</b> When the evaporation temperature (tS5) is lower than the LOP threshold, the controller interrupts superheat regulation and the valve opens. The valve opening speed depends not only on the difference between the evaporation temperature and the LOP threshold, but also on the ELO integral time parameter: the lower it is, the higher the valve opening speed will be. When this protection is activated, the Lod count starts for the activation of the LOP alarm. LSH SECURITY TAKES PRIORITY OVER LOP SECURITY. THE LOP PROTECTION IS NOT ACTIVATED DURING THE START PHASE (EST TIME), DURING THE DEFROST OR POST-DEFROST PHASE (Edt TIME).	0 = LOP protection and related LOP alarm signaling disabled  0 ÷ 500 seconds steps of 2 seconds	0
Lod	<b>LOP alarm activation delay:</b> the LOP alarm is signaled only after it has remained active for the LOd time. In case of LOP alarm. The alarm is self-resetting when "Temp.S5" ≥ LOP. With active alarm we have: - Written LOP flashing on the display. - Buzzers.	0 ÷ 240 tens of seconds	30
tPF	<b>Forced valve positioning.</b> At any time via digital input (if the controller is not in standby) it is possible to force the opening of the valve to a pre-set value.	0 ÷ 100 %	50%

**NOTE:** all the calculation times of the LSH, MOP, LOP alarms are reset when the regulation stops OR DURING THE START PHASE (Est TIME), DURING THE DEFROST OR POST-DEFROST PHASE (Edt TIME).

**Loading default settings based on EEV parameter:**

	EEV = 1 DEFAULT PEGO	EEV = 2 (ROOM or TN REFRIGERATED COUNTER control with on-board compressor)	EEV = 3 (ROOM or BT REFRIGERATED COUNTER control with on-board compressor)	EEV = 4 (ROOM or DUCTED TN REFRIGERATED COUNTER control)	EEV = 5 (ROOM or DUCTED BT REFRIGERATED COUNTER control)
ESH	6°C	6°C	6°C	11°C	11°C
EPb	15%	15%	15%	15%	15%
Etl	100s	100s	100s	150s	150s
Etd	2,0s	2,0s	2,0s	5,0s	5,0s
LSH	2°C	2°C	2°C	5°C	5°C
ELS	2	2	2	2	2
MOP	+45°C	5°C	-15°C	+5°C	-15°C
EMO	0	5	5	5	5
LOP	-45°C	-25°C	-45°C	0	0
ELO	0	15	15	0	0

## Valve management (EEV parameter)

5.9.1

Setting the EEV parameter from 1 to 5 loads the default values in the variables **ESH, EPb, Etl, Etd, LSH, ELS, MOP, EMO, LOP, ELO**. In this case **the controller acts as a superheat regulator**, based on the value read by the connected pressure/temperature probes.

Setting value 6 enables the valve position command via Modbus (register 1536): the control sets the valve opening value received via Modbus and **no superheat control is performed**. In this case it is not necessary to connect the probes and the alarms E4, E5 LSH, MOP, LOP are disabled. The position must be communicated within 60 seconds to avoid closing the valve.

Setting value 7 enables the valve position command via 0-10V input: the control sets the valve opening value calculated based on the input and **no superheat control is performed**. In this case it is not necessary to connect the probes and the alarms E4, E5 LSH, MOP, LOP are disabled. Connect the 0-10V input to terminals 11 (GND) -12 (+V) of the PEV S27, as indicated in attachment A.2.

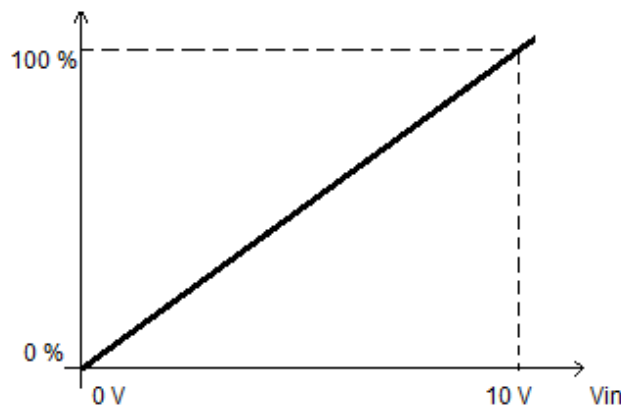

## 3rd LEVEL PROGRAMMING (Stepper valve parameters)

5.10

**Via the myPego app:**

- Open the myPego app and connect to the instrument called "NEXUSS27" via Bluetooth or via cloud.
- Touch the "Parameters" button in the bottom toolbar.
- Consult / modify the parameters of the desired level.

**With remote console:**

To access Level 3 programming, press and hold the UP key, SET key and STANDBY key for over 3 seconds. When the first programming parameter appears:

1. Use the (▲) key or (▼) key to select the parameter to be modified. After selecting the required parameter, it will be possible to:
  - View its configuration by pressing the SET key.
  - Edit configuration by pressing and holding the SET key and pressing either the (▲) key or the (▼) key.
2. After setting the configuration values, press and hold both the (▲) key and the (▼) key until the value of the main display reappears and exit the menu.
3. Any changes made to the parameters are saved automatically when the system closes the configuration menu.

Entering this menu, adjustment is interrupted and the valve is closed.

**Possible electrical damage! => make changes in this programming level with the valve disconnected. On exiting, the valve is completely closed. On first start-up, the type of valve must be set (parameter "tEU"). It's not possible to modify the parameters relating to the coded valves (tEU >=1).**



5.11

3rd LEVEL PARAMETERS LIST (Stepper valve parameters)

PAR.	MEANING	VALUES	DEFAULT
tEU	<p><b>Type of motorized valve connected.</b></p> <p>Settings 1 to 21 load default values into the LSP, HSP, CSP, SPD, ICF, ICM, SYN parameters (see table on page 34).</p> <p>However, you can change the values by default set automatically by setting tEU=0.</p> <p>Pressing the <b>Set</b> key only to see the current tEU value does not load the defaults.</p>	<p>-2= Valve disabled                      -1= Valve not configured                      0 = Customized (set EEV parameters)                      1 = Carel EXV                      2 = Danfoss ETS 25-50                      3 = Danfoss ETS 100                      4 = Danfoss ETS 250/400                      5 = NOT USED                      6 = Alco EX4                      7 = Alco EX5                      8 = Alco EX6                      9 = Alco EX7                      10 = Alco EX8 500                      11 = Sporlan SEI 0.5-11                      12 = Sporlan SER 1.5-20                      13 = Sporlan SER(I) G, J, K                      14 = Sporlan SEI 30                      15 = Sporlan SEI 50                      16 = Sporlan SEH 100                      17 = Sporlan SEH 175                      18 = Castel 261 / 271                      Eliwell SXVB261                      19 = Castel 262 / 263                      Eliwell SXVB262 / SXVB263                      20 = Castel 272 / 273                      21 = Castel 264 / 274                      Eliwell SXVB264</p>	-1
LSP	<p><b>Minimum number of steps</b></p> <p>Allows selection of the minimum number of steps of the valve to which the valve should be considered completely closed. The manufacturer's manual of the valve must be read to correctly set this parameter. It's the minimum number of steps to remain within the operating range recommended by the manufacturer.</p>	0 ÷ HSP-1 (10*steps)	5
HSP	<p><b>Maximum number of steps</b></p> <p>Allows you to select the maximum number of steps which can be executed by the valve. At this number of steps, the valve should be completely open. The manufacturer's manual of the valve must be read to correctly set this parameter. It's the maximum number of steps to stay within the operating range recommended by the manufacturer.</p>	LSP+1 ÷ CSP (10* steps)	48
CSP	<p><b>Closure steps</b></p> <p>Number of additional steps to take to complete closure of the valve, used to re-align the valve in the physical fully closed position. Driver and valve are therefore ready for adjustment and alignment both on 0 (zero).</p> <p>On switching on the controller and periodically, forced closure is therefore carried out, to re-align the valve at the position calculated by the driver.</p>	HSP ÷ 999 (10* steps)	50
Spd	<p><b>Nominal speed</b></p> <p>Maximum movement speed of the motor without losing steps and therefore without loss of precision. It's necessary to stay under the maximum speed available for the valve.</p>	1 ÷ 999 step/sec	50
ICF	<p><b>Nominal current per phase (bipolar valves)</b></p> <p>It's the current per phase used by the valve during adjustment. Consult the manufacturer's manual.</p>	ICM+1 ÷ 800 mA	450
ICM	<p><b>Stationary current (bipolar valves).</b> It's the current per phase when the valve is stopped for at least 5 minutes.</p>	0 ÷ ICF-1 mA	100
dut	<p><b>Valve duty cycle</b></p> <p>Fraction of time during which the valve is controlled.</p>	0 ÷ 100 %	100

PAR.	MEANING	VALUES	DEFAULT
<b>SYN</b>	<b>Active synchronisation</b> Each time the valve must be completely opened or closed, a certain number of steps more is executed to achieve complete opening/closure of the valve	0 = disabled 1 = enabled in opening 2 = enabled in closure 3 = enabled in opening and closure	0
<b>CTr</b>	<b>Types of adjustment</b> Sets the type of current adjustment of the stepper motor. A microstep or half-step control ensures smoother movement (with current modulation), however this causes torque reduction. With the full-step control, the windings are always piloted to the maximum current, but movement is not as smooth.	0 = Microstep 1 = Full – step 2 = Half - step	0

**Loading of default settings based on the tEU parameter:**

tEU	LSP (x10) step	HSP (x10) step	CSP (x10) step	Spd (step/s)	ICF (mA)	ICM (mA)	SYN
-1 = Valve not configured	---	---	---	---	---	---	---
0 = Customized	5	48	50	50	450	100	2
1 = Carel EXV	5	48	50	50	450	100	2
2 = Danfoss ETS 25-50	7	262	262	300	100	100	2
3 = Danfoss ETS 100	10	353	353	300	100	100	2
4 = Danfoss ETS 250/400	11	381	381	300	100	100	2
5 = Not used	-	-	-	-	-	-	-
6 = Alco EX4	10	75	75	500	500	100	2
7 = Alco EX5	10	75	75	500	500	100	2
8 = Alco EX6	10	75	75	500	500	100	2
9 = Alco EX7	10	160	160	500	750	250	2
10 = Alco EX8 500	10	260	260	500	800	500	2
11 = Sporlan SEI 0.5-11	10	160	360	200	200	50	2
12 = Sporlan SER 1.5-20	10	160	360	200	200	50	2
13 = Sporlan SER(I) G, J, K	10	250	350	200	200	50	2
14 = Sporlan SEI 30	20	319	360	200	200	50	2
15 = Sporlan SEI 50	40	639	750	200	200	50	2
16 = Sporlan SEH 100	40	639	750	200	200	50	2
17 = Sporlan SEH 175	40	639	750	200	200	50	2
18 = Castel 261 / 271 Eliwell SXVB261	0	41	51	35	200	50	2
19 = Castel 262 / 263 Eliwell SXVB262 / SXVB263	0	20	25	20	200	50	2
20 = Castel 272 / 273	0	41	51	35	300	50	2
21 = Castel 264 / 274 Eliwell SXVB264	0	99	113	70	560	50	2

5.12

QUICK VIEW MENU (READ-ONLY)

During the start-up of the system it may be useful to simply check the reading of the various probes or of some values to verify or optimize the process. To access these values:

**Via the myPego app:**

1. Open the myPego app and connect to the instrument called "NEXUSS27" via Bluetooth or via cloud.
2. The process regulation probes are immediately visible below the superheat value.

**With remote console:**

To access the quick display menu, press and hold down the DOWN (▼) and STAND-BY keys for more than 3 seconds. Within this menu, the up or down arrows allow you to scroll through the different parameters. Pressing the Set key alternates the display of the parameter with its value (to facilitate reading, pressing the SET key switches between parameter and value: it is not necessary to keep it pressed). With the value of the parameter displayed, pressing the up or down arrow keys in any case displays the parameter following or preceding the current one (therefore it automatically exits from displaying the value). This menu is exited automatically after 2 minutes of console inactivity or by pressing the up arrow (▲) + down arrow (▼) keys simultaneously for a few seconds.

QUICK VIEW MENU PARAMETER LIST (READ-ONLY)

5.13

PARAMETERS	MEANING	VALUES
tS4	View Inlet Temperature sensor (S4)	(read-only) °C
tS5	View Evaporation Temperature sensor (S5)	(read-only) °C
PS5	View Evaporation Pressure sensor (S5)	(read-only) Bar
tSH	View superheat temperature	(read-only) °C
oEV	EEV valve opening percentage	(read-only) %
PAS	EEV Valve opening position	(read-only) steps/10

5.14

REFRIGERANT TEMPERATURE TABLE

The following table shows the evaporation temperature limits (tS5, see chapter 5.13) according to the type of refrigerant fluid (ErE parameter).

Parameter ErE	Code	Temperature range	Parameter ErE	Code	Temperature range
0	R404	-50 ÷ 70 °C	11	R449A	-50 ÷ 70 °C
1	R134A	-50 ÷ 70 °C	12	R290	-50 ÷ 70 °C
2	R22	-50 ÷ 70 °C	13	R32	-50 ÷ 70 °C
3	R407A	-50 ÷ 70 °C	14	R448A	-50 ÷ 70 °C
4	R407F	-50 ÷ 70 °C	15	R452A	-50 ÷ 70 °C
5	R407H	-50 ÷ 70 °C	16	R600	-20 ÷ 70 °C
6	R410A	-50 ÷ 70 °C	17	R600A	-30 ÷ 70 °C
7	R450A	-40 ÷ 70 °C	18	R1270	-50 ÷ 70 °C
8	R507	-50 ÷ 70 °C	19	R1234ZE	-30 ÷ 70 °C
9	R513A	-45 ÷ 70 °C	20	R23	-50 ÷ 25 °C
10	R744 (CO2)	-50 ÷ 40 °C	21	R717 (NH3)	-50 ÷ 70 °C
			22	R454C	-50 ÷ 70 °C

## PASSWORD FUNCTION (only on remote console)

5.15

The password function is enabled by setting a value other than 0 in the PA parameter. See parameter P1 for the various levels of protection. Protection is enabled automatically when the keypad is not used for 30 seconds. The digits 000 appear on the display. Use the up/down arrow keys to edit the number and press the SET key to confirm. The 000 password window disappears if the keypad is not used for 30 seconds. **Note:** If you forget the password, use the universal number **100**.

## FIRST START PROCEDURE

5.16

At first start-up it's necessary to configure the third level valve parameters. The first start procedure is as follows:

- 1) **With the valve disconnected** (terminals 12/13/14/15 disconnected) turn on the NEXUS S27 control. The control is in the "CFG" alarm state to signal that the valve needs to be configured.
- 2) Carry out the valve configuration: set the third level parameter "tEU" (via remote display or myPego app) according to the type of valve connected, or configure the necessary parameters (see chapter 5.11).
- 3) Turn off the NEXUS S27 control by removing power.
- 4) **Suitably connect the electronic valve (see appendix A2 and A4) with control off.**
- 5) Turn on the NEXUS S27 control. On power-up, after an initialisation phase (the remote display shows "ini" and the valve is completely closed), the controller, if enabled by the digital input, starts superheat regulation. Then set all the necessary parameters based on the type of application (superheat setpoint, etc.).

## SOFTWARE UPDATE

5.17

Contact Pego at: [tecnico@pego.it](mailto:tecnico@pego.it) .

## EXPORT / IMPORT PARAMETERS

5.18

It's possible to export / import the parameters set in the NEXUS S27 via the USB port on board. To do this you need the optional remote display.

1. Insert the USB memory into the slot on the electronic board.
2. Press the SET + STANDBY keys for 5 seconds and select the item "PrE" to export the parameters, "Pri" to import the parameters from the USB (in this case there must be a previously exported file on the USB memory).
3. Press the SET key to confirm. The NEXUS controller automatically exports / imports the set parameters and the device status.

**Note:** the generated files (name: NEXS27\_1.PAR and NE27\_ESP.bkp) can be imported to other NEXUS S27 controllers to obtain identically configured instruments.

# CHAPTER 6: OPTIONS

## 6.1

### TELENET MONITORING/SUPERVISION SYSTEM

To connect the electrical panel to a **TeleNET** network, follow the diagram below. Refer to the **TeleNET** user manual for instrument configuration.  
**IMPORTANT:** During the configuration, under "Module" select "PEV-PULSE Instrument".

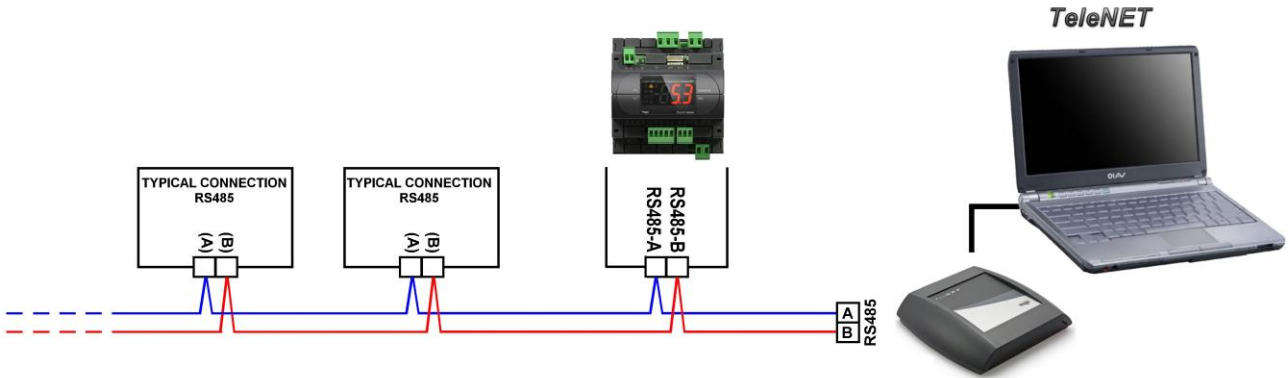

## 6.2

### NETWORK CONFIGURATION WITH MODBUS-RTU PROTOCOL

Connect the board to a RS485 network with **Modbus-RTU** protocol with reference to the diagram below. Refer to the MODBUS-RTU\_NEXUSS27 manual (available on our website) for the specifications of the MODBUS-RTU communication protocol.

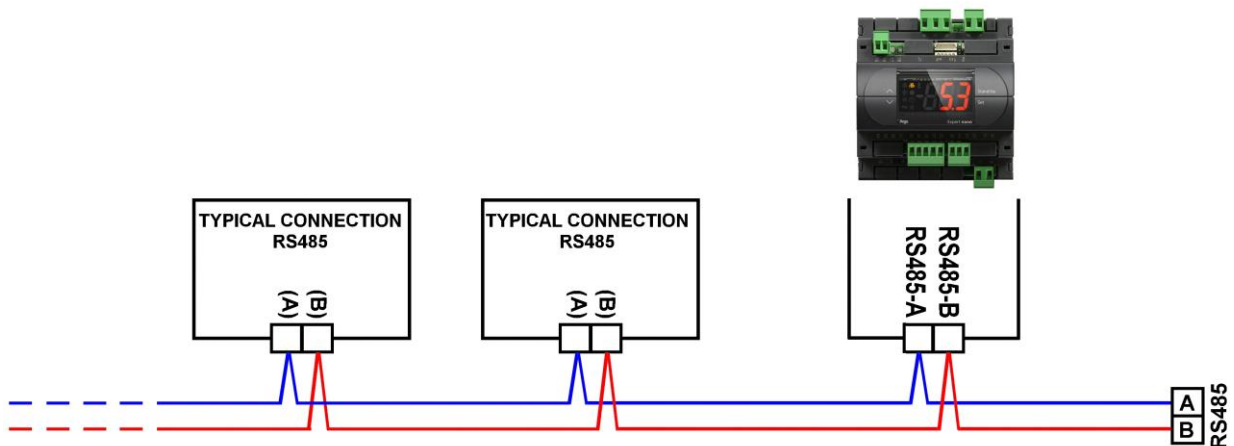

# CHAPTER 7: DIAGNOSTICS

## DIAGNOSTICS

### 7.1

In the event of any anomalies, the **NEXUS S27** controller warns the operator through alarm codes displayed on the remote display or with notification via the myPego app.

CODE	POSSIBLE CAUSE	OPERATION TO BE PERFORMED
E4	<b>Functional anomaly of the suction temperature probe (S4).</b>	<ul style="list-style-type: none"> <li>• Check the status of the probe and its connections.</li> <li>• If the problem persists, replace the probe.</li> </ul>
E5	<b>Functional anomaly of the Evaporation pressure probe (S5).</b>	<ul style="list-style-type: none"> <li>• Check the status of the probe and its connections.</li> <li>• If the problem persists, replace the probe.</li> </ul>
LSH	<b>Low superheat alarm.</b>	<ul style="list-style-type: none"> <li>• Check the status of the refrigeration system.</li> <li>• Modify the PID parameters.</li> <li>• If the problem persists, contact the technical assistance service.</li> </ul>
MOP	<b>Alarm for maximum saturated evaporation temperature exceeded, in relation to sensor S5.</b>	<ul style="list-style-type: none"> <li>• Check the status of the refrigerating system.</li> <li>• Edit the PID parameters.</li> <li>• If the problem persists, contact the technical assistance service.</li> </ul>
LOP	<b>Alarm for minimum saturated evaporation temperature exceeded, in relation to sensor S5.</b>	<ul style="list-style-type: none"> <li>• Check the status of the refrigerating system.</li> <li>• Edit the PID parameters.</li> <li>• If the problem persists, contact the technical assistance service.</li> </ul>
En	<b>No connection between remote display and unit.</b>	<ul style="list-style-type: none"> <li>• Check the connection between the remote display and the unit.</li> <li>• If the problem persists, contact the technical assistance service.</li> </ul>
VAL	<b>Valve Alarm.</b> An overcurrent or overheating alarm was detected of the valve. Management of the valve is disabled. On re-entering the alarm, the valve re-initializes in the total closure position.	<ul style="list-style-type: none"> <li>• Check configuration and the connections of the valve.</li> <li>• Switch off and back on the equipment.</li> <li>• If the problem persists, contact the technical support service.</li> </ul>
CFG	<b>Valve not configured.</b> On first start-up, configuration is requested of the type of valve connected.	<ul style="list-style-type: none"> <li>• Configure the type of valve connected by setting the third level parameter "tEU".</li> </ul>
ini	<b>Initialization in progress (closure complete).</b>	<ul style="list-style-type: none"> <li>• Wait for the initialization procedure to complete.</li> </ul>
E0 E0i E0E	<b>Eeprom alarm.</b> An EEPROM memory fault has been detected.	<ul style="list-style-type: none"> <li>• Switch unit off and then back on.</li> <li>• Restore the default values (see dEF parameter).</li> </ul>
EP1	<b>Lack of power supply Alarm.</b> The emergency close digital input has been activated by the backup module.	<ul style="list-style-type: none"> <li>• Check for the presence of mains power to the backup module.</li> <li>• Check the status of the digital input configured as "Emergency closure".</li> </ul>
ES1 C1	<b>Connectivity module alarm.</b>	<ul style="list-style-type: none"> <li>• Turn the equipment off and on again.</li> <li>• If the problem persists, contact the technical support service.</li> </ul>
EU1..EU9	<b>USB communication error.</b> An error occurred while exporting/importing data to USB.	<ul style="list-style-type: none"> <li>• Turn the equipment off and on again.</li> </ul>

# ANNEXES

## A.1

### DICHIARAZIONE DI CONFORMITA' UE / EU CONFORMITY

LA PRESENTE DICHIARAZIONE DI CONFORMITA' È RILASCIATA SOTTO LA RESPONSABILITA' ESCLUSIVA DEL FABBRICANTE:

*THIS DECLARATION OF CONFORMITY IS ISSUED UNDER THE EXCLUSIVE RESPONSIBILITY OF THE MANUFACTURER:*



PEGO S.r.l. a socio unico - Via Piacentina 6/b, 45030 Occhiobello (RO) – Italy –  
Società soggetta all'attività di direzione e coordinamento di Castel S.r.l.

### DENOMINAZIONE DEL PRODOTTO IN OGGETTO / DENOMINATION OF THE PRODUCT IN OBJECT

MOD.: NEXUS S27

IL PRODOTTO DI CUI SOPRA È CONFORME ALLA PERTINENTE NORMATIVA DI ARMONIZZAZIONE DELL'UNIONE EUROPEA:

*THE PRODUCT IS IN CONFORMITY WITH THE RELEVANT EUROPEAN HARMONIZATION LEGISLATION:*

Direttiva Bassa Tensione (LVD): **2014/35/UE**  
*Low voltage directive (LVD): 2014/35/EU*

Direttiva EMC: **2014/30/UE**  
*Electromagnetic compatibility (EMC): 2014/30/EU*

LA CONFORMITA' PRESCRITTA DALLA DIRETTIVA È GARANTITA DALL'ADEMPIMENTO A TUTTI GLI EFFETTI DELLE SEGUENTI NORME:

*THE CONFORMITY REQUIRED BY THE DIRECTIVE IS GUARANTEED BY THE FULFILLMENT TO THE FOLLOWING STANDARDS:*

Norme armonizzate: **EN 60335-1:2012, EN 61000-6-1:2007, EN 61000-6-3:2007**  
*European standards: EN 60335-1:2012, EN 61000-6-1:2007, EN 61000-6-3:2007*

IL PRODOTTO È COSTITUITO PER ESSERE INCORPORATO IN UNA MACCHINA O PER ESSERE ASSEMBLATO CON ALTRI MACCHINARI PER COSTITUIRE UNA MACCHINA CONSIDERATE DALLA DIRETTIVA: 2006/42/CE "Direttiva Macchine".

*THE PRODUCT HAS BEEN MANUFACTURED TO BE INCLUDED IN A MACHINE OR TO BE ASSEMBLED TOGETHER WITH OTHER MACHINERY TO COMPLETE A MACHINE ACCORDING TO DIRECTIVE: EC/2006/42 "Machinery Directive".*

Firmato per nome e per conto di:  
*Signed for and on behalf of:*

Pego S.r.l.  
Martino Villa  
Presidente

Luogo e Data del rilascio:  
*Place and Date of Release:*

Occhiobello (RO), 01/07/2023

CONNECTION DIAGRAM

A.2

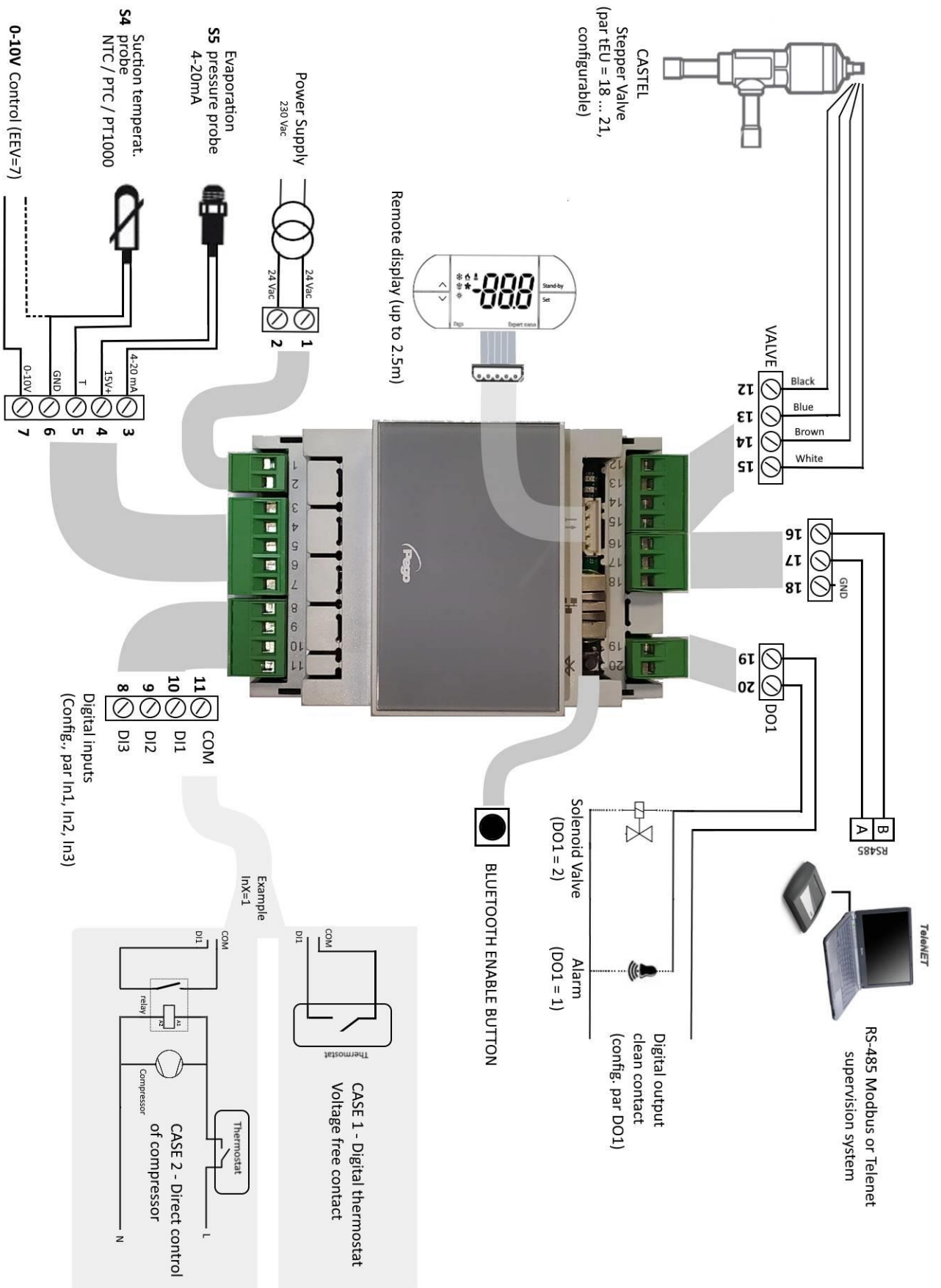



## A.3

## LAYOUT AND DESCRIPTION OF SENSORS

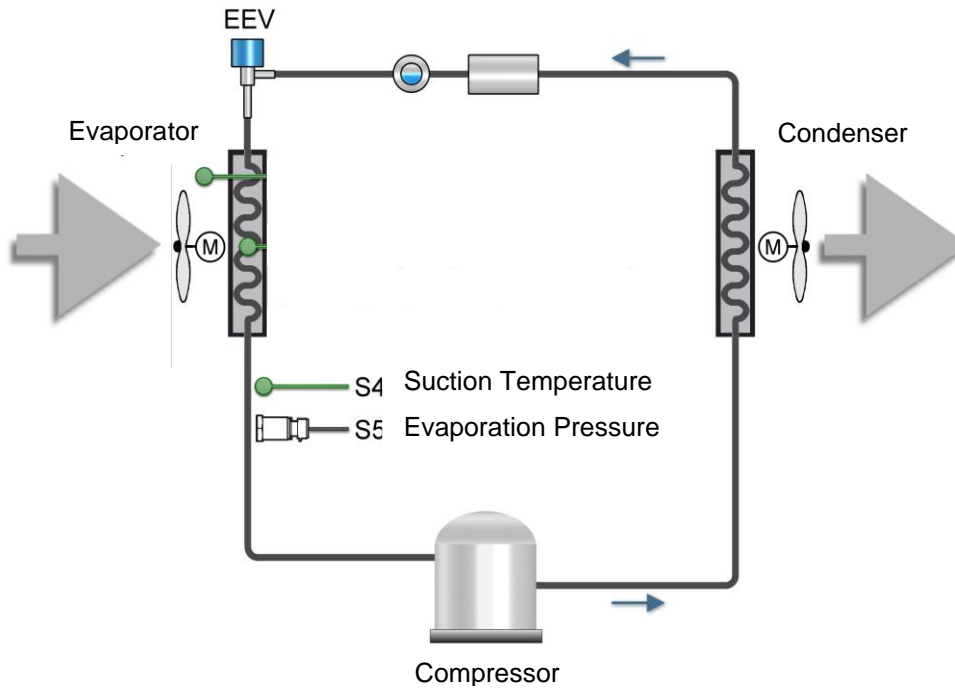

## A.4

## VALVES CONNECTION

Valve (par. tEU)	PIN 15	PIN 14	PIN 13	PIN 12
1 = Carel EXV	GREEN	BROWN	YELLOW	WHITE
2 = Danfoss ETS 25-50	GREEN	RED	WHITE	BLACK
3 = Danfoss ETS 100	GREEN	RED	WHITE	BLACK
4 = Danfoss ETS 250/400	GREEN	RED	WHITE	BLACK
5 = Not used	-	-	-	-
6 = Alco EX4	BLUE	BROWN	WHITE	BLACK
7 = Alco EX5	BLUE	BROWN	WHITE	BLACK
8 = Alco EX6	BLUE	BROWN	WHITE	BLACK
9 = Alco EX7	BLUE	BROWN	WHITE	BLACK
10 = Alco EX8 500	BLUE	BROWN	WHITE	BLACK
11 = Sporlan SEI 0.5-11	GREEN	RED	BLACK	WHITE
12 = Sporlan SER 1.5-20	GREEN	RED	BLACK	WHITE
13 = Sporlan SER(I) G,J,K	GREEN	RED	BLACK	WHITE
14 = Sporlan SEI 30	GREEN	RED	BLACK	WHITE
15 = Sporlan SEI 50	GREEN	RED	BLACK	WHITE
16 = Sporlan SEH 100	GREEN	RED	BLACK	WHITE
17 = Sporlan SEH 175	GREEN	RED	BLACK	WHITE
18 = Castel 261-271 / Eliwell SXVB261	WHITE(2)	BROWN(1)	BLUE(3)	BLACK(4)
19 = Castel 262-263 / Eli. SXVB262-263	WHITE (2)	BROWN (1)	BLUE(3)	BLACK (4)
20 = Castel 272-273	WHITE (2)	BROWN (1)	BLUE(3)	BLACK (4)
21 = Castel 264 -274 / Eliwell SXVB264	WHITE (2)	BROWN (1)	BLUE(3)	BLACK (4)







**PEGO s.r.l.**  
**Via Piacentina, 6/b 45030 Occhiobello (RO) - ITALY**  
**Phone. +39 0425 762906**  
**e-mail: info@pego.it – www.pego.it**

**TECHNICAL ASSISTANCE**  
**Phone +39 0425 762906 e-mail: tecnico@pego.it**

Distributor: